

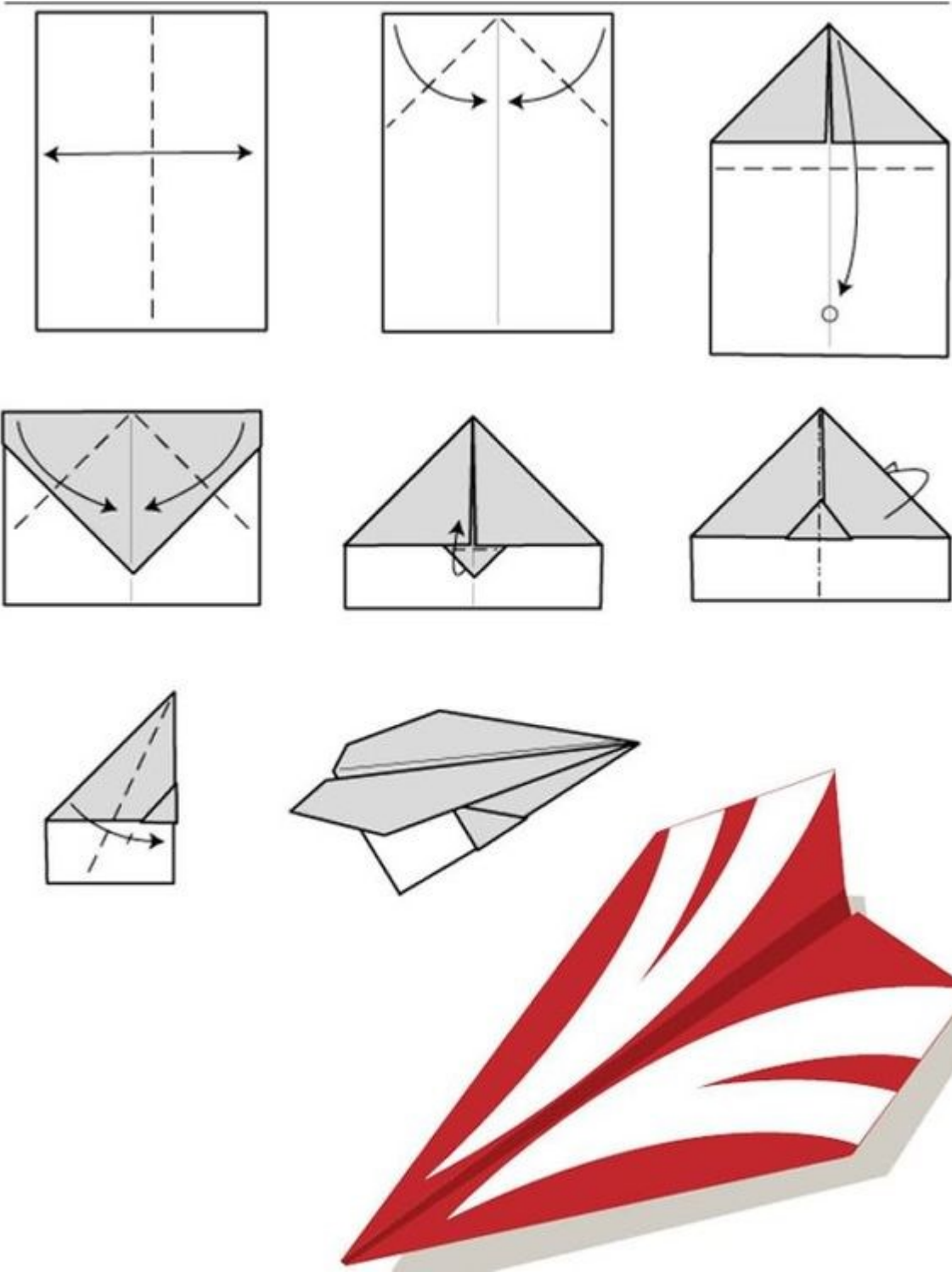

Avion





Baleine

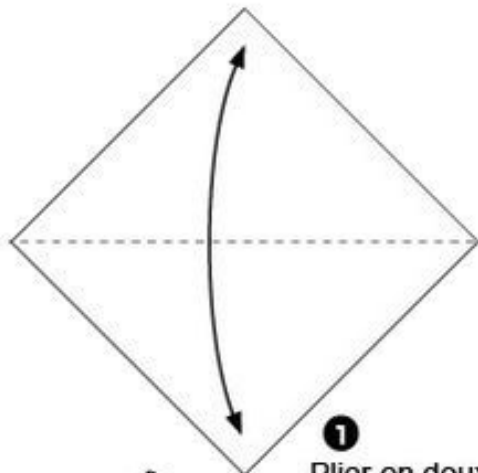

1 Plier en deux pour tracer un pli et réouvrir

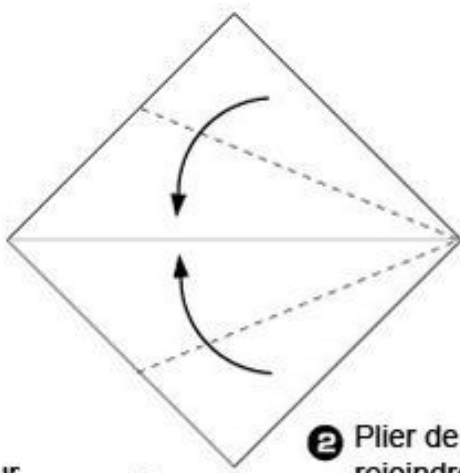

2 Plier de façon à rejoindre la ligne centrale

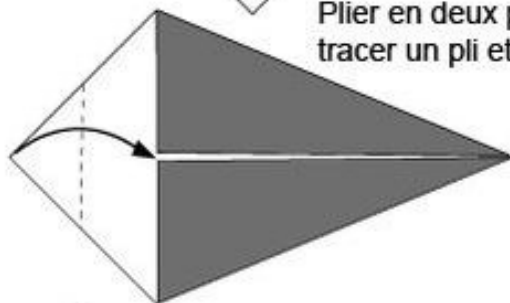

3 Plier en suivant les pointillés

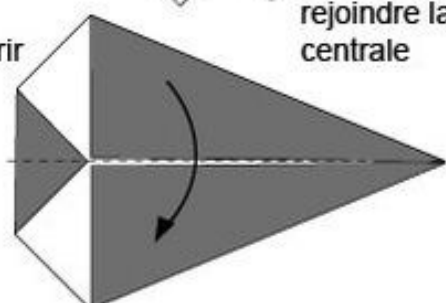

4 Plier en deux

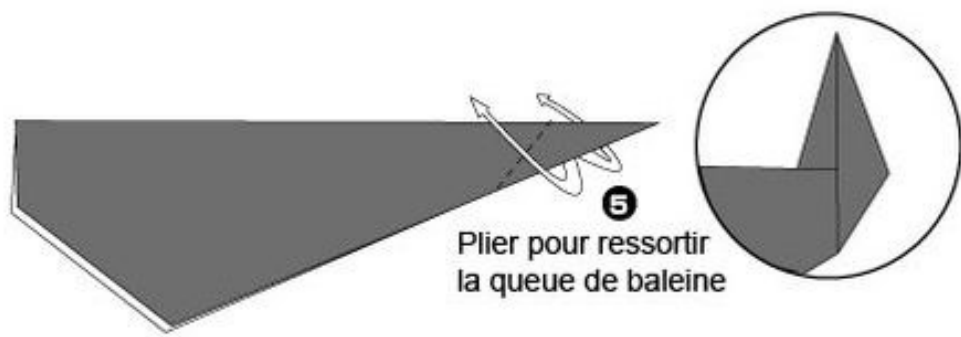

5 Plier pour ressortir la queue de baleine

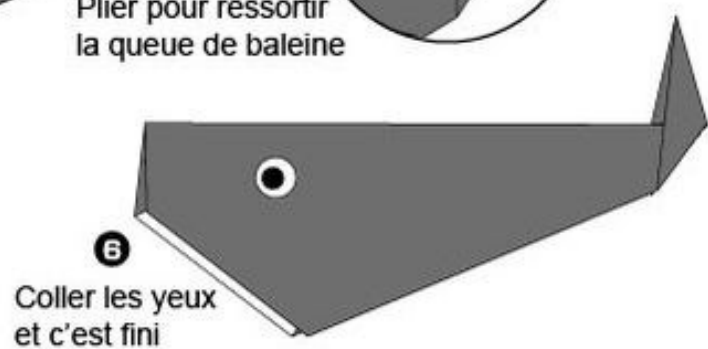

6 Coller les yeux et c'est fini



Calamar

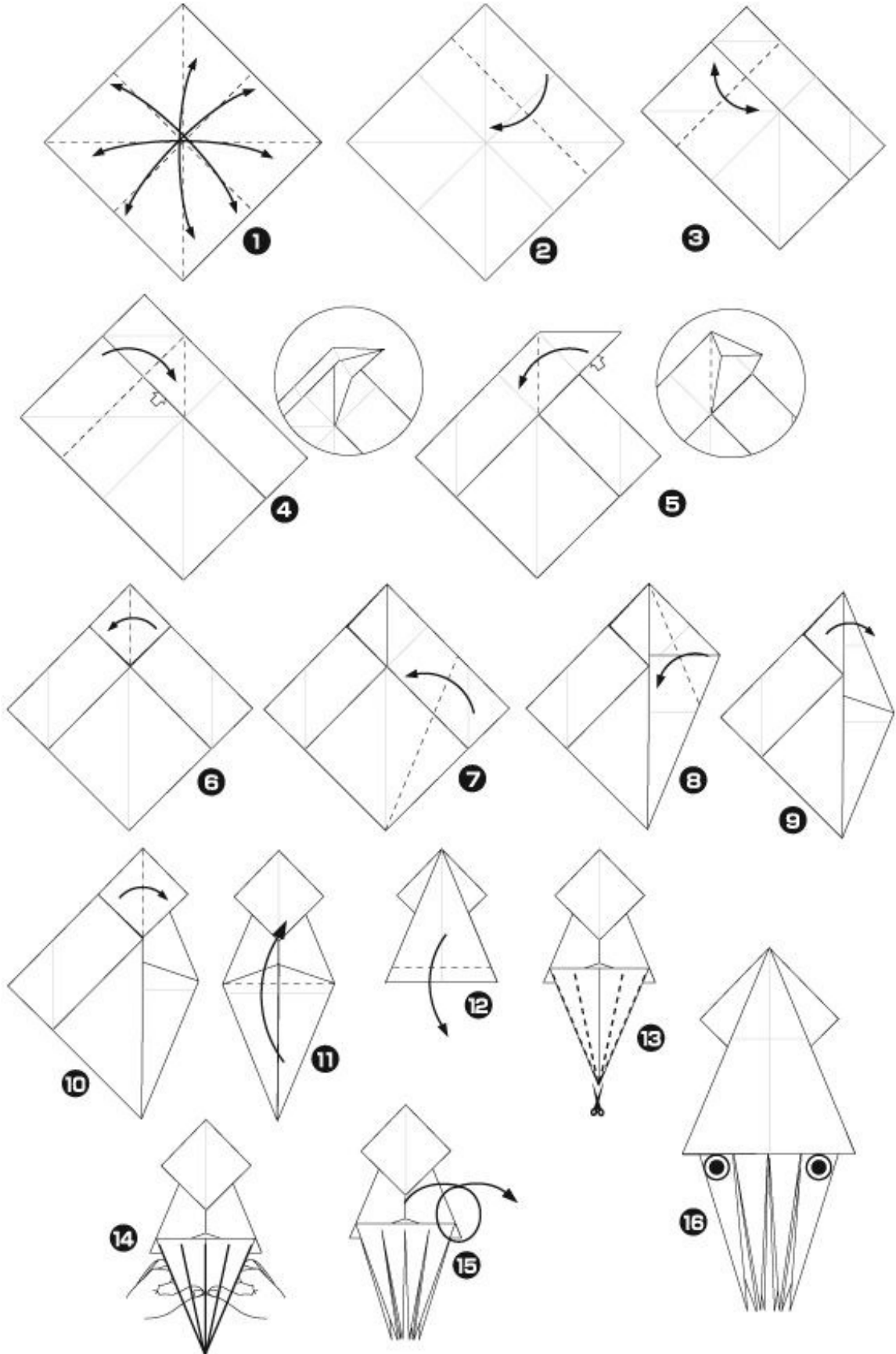



Carambole

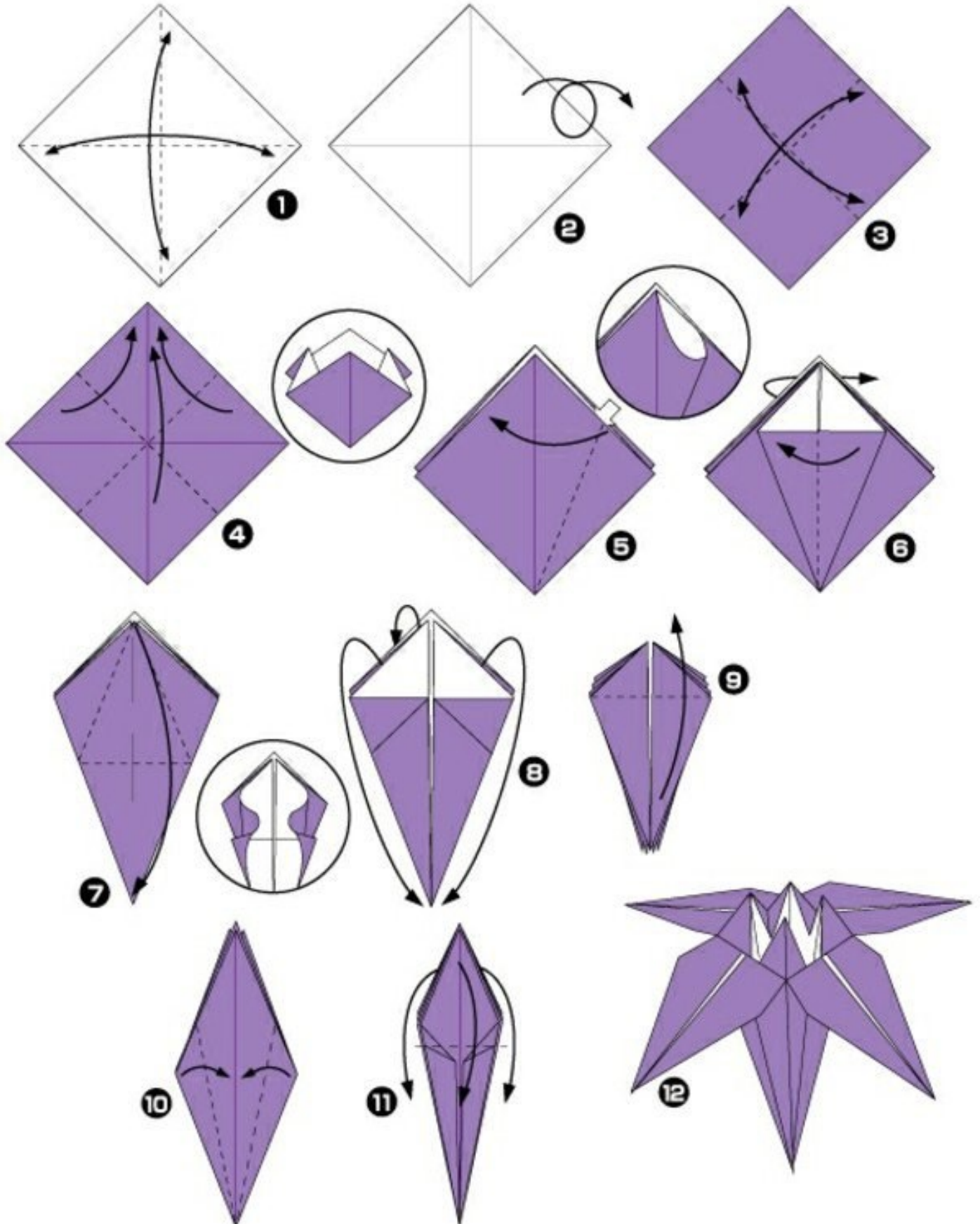



Chat

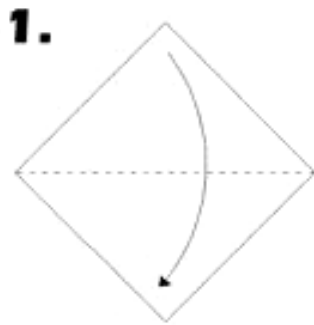

Plier la feuille en deux

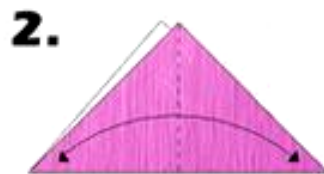

Plier en deux en suivant les pointillés

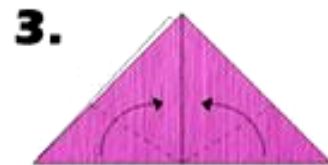

Plier en suivant les pointillés

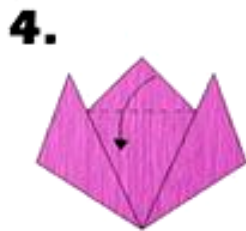

Faire un pli en suivant la ligne des pointillés



Retournez votre origami



Dessinez un visage

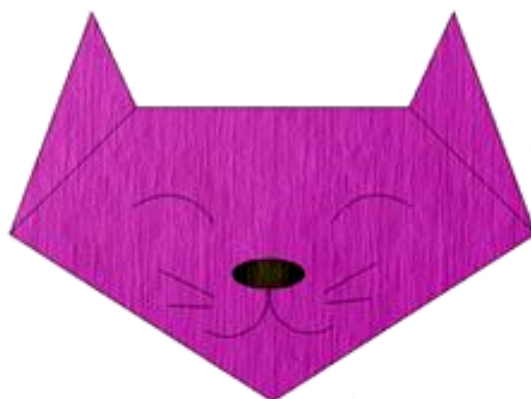



Cheval

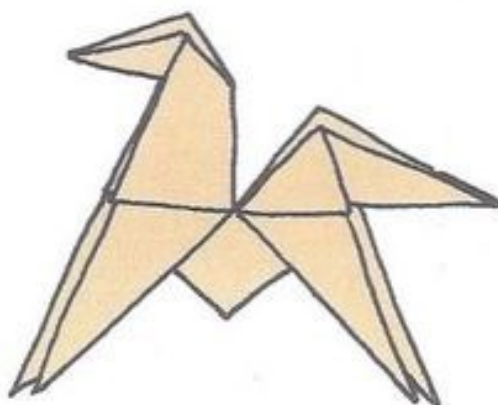
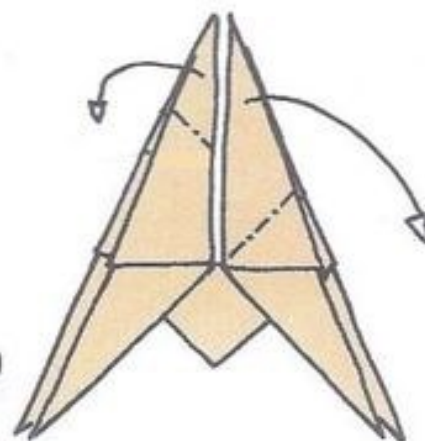
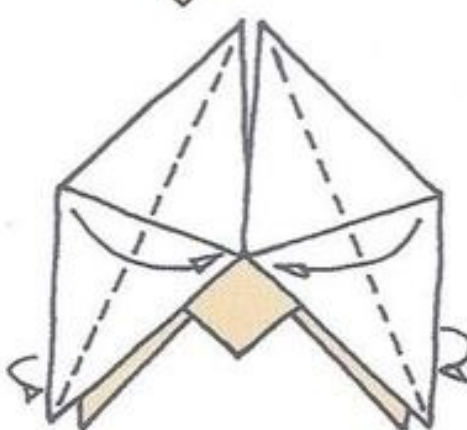
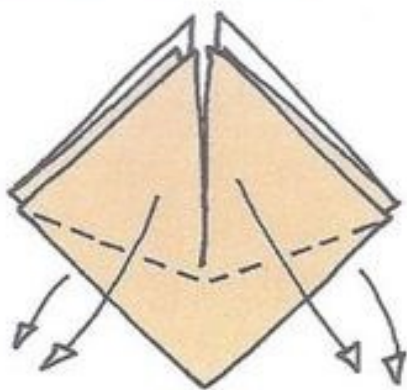
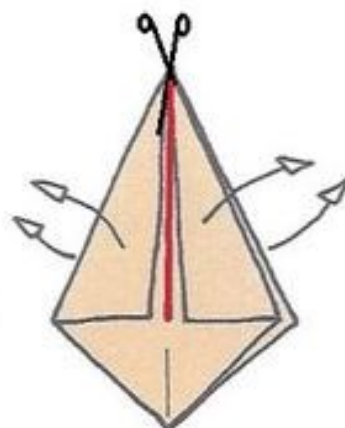
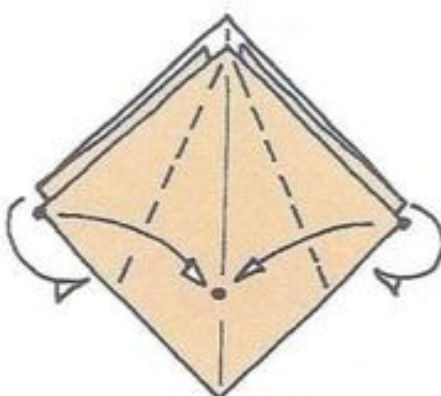
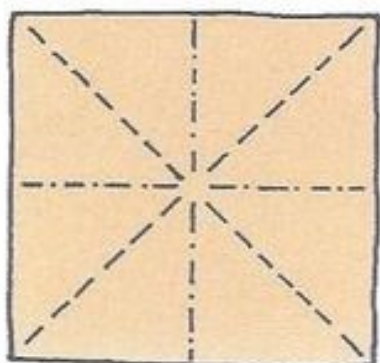



Chien

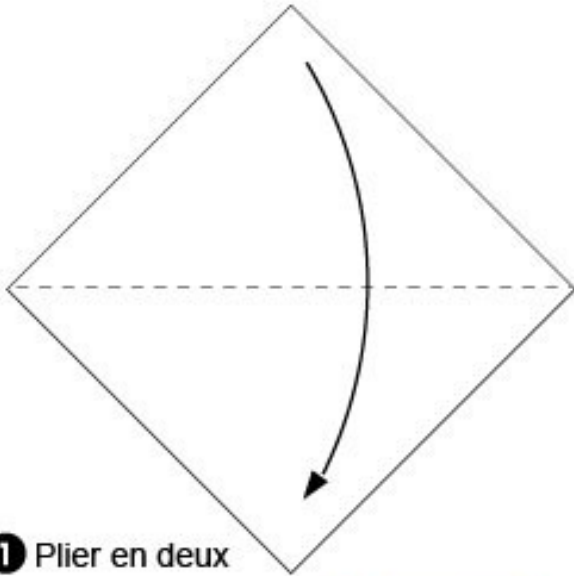

1 Plier en deux

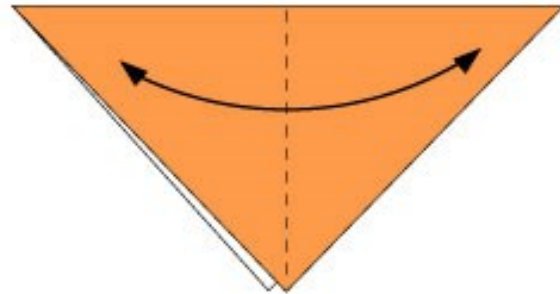

2 Plier en deux pour tracer le pli

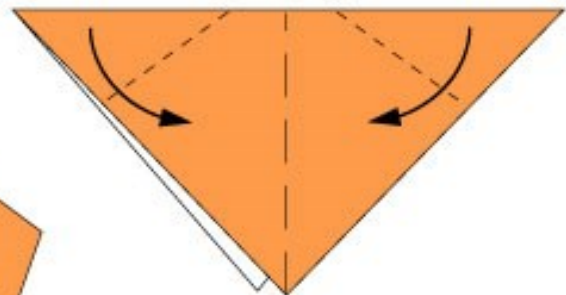

3 Plier en suivant les pointillés

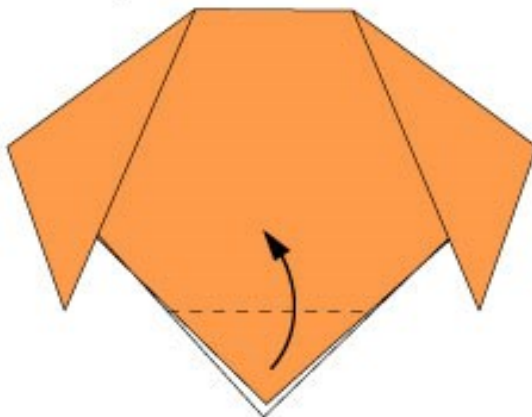

4 Plier en suivant les pointillés

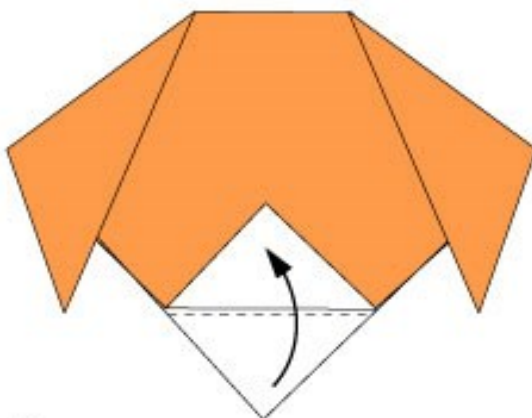

5 Plier en suivant les pointillés

6
Dessiner
un visage
et c'est fini

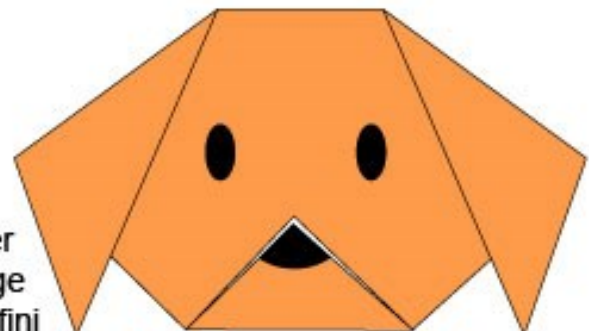



Pigeon

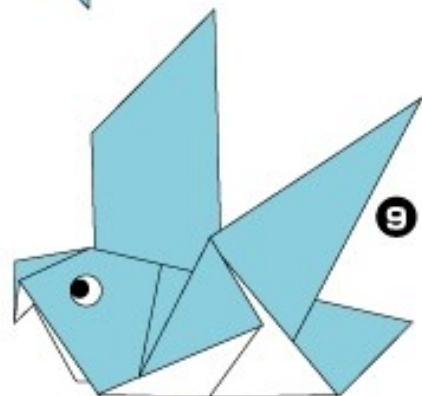
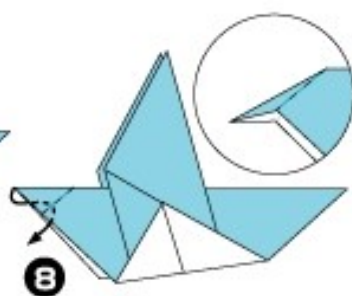
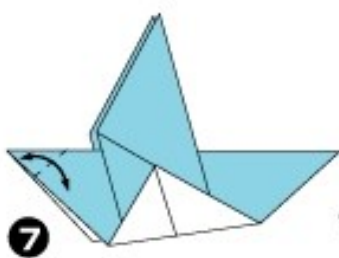
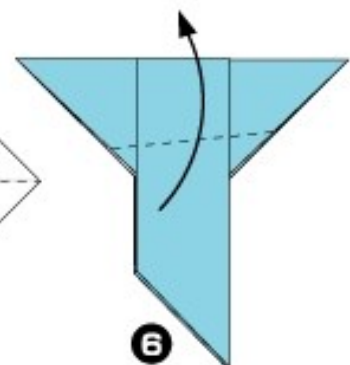
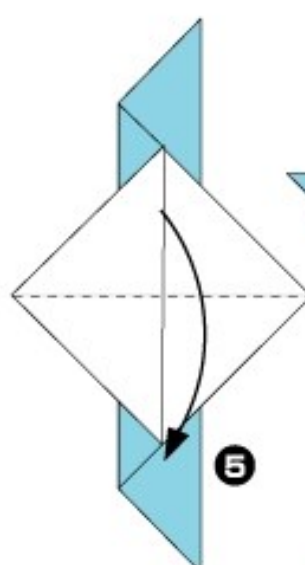
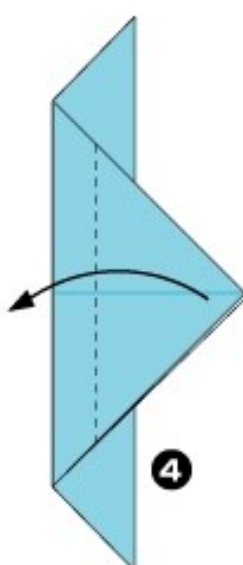
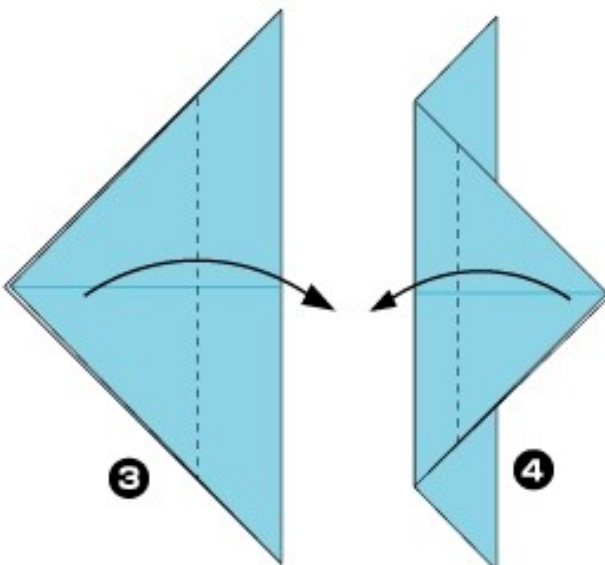
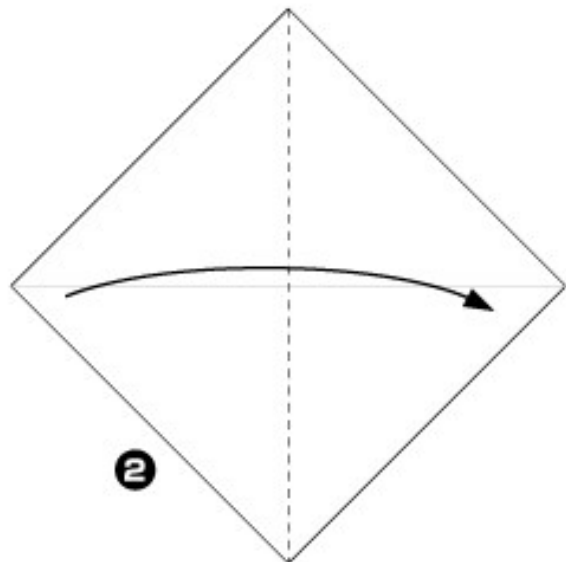
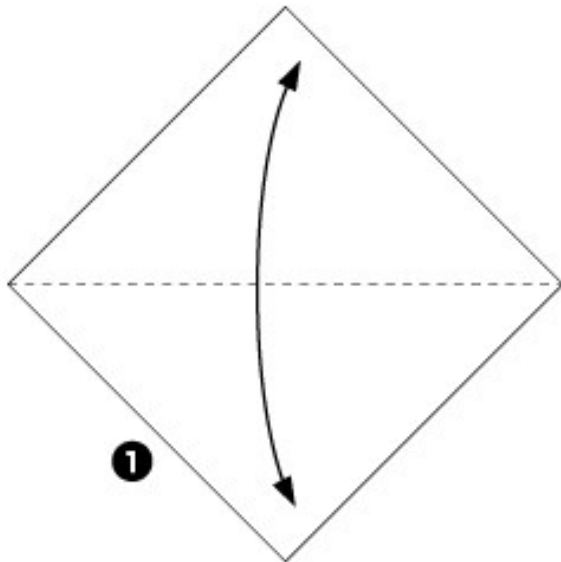



Cochon

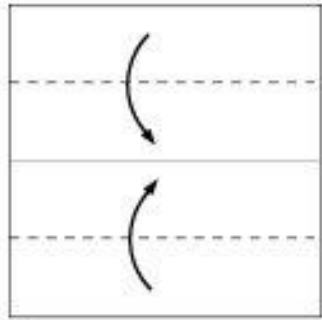

1

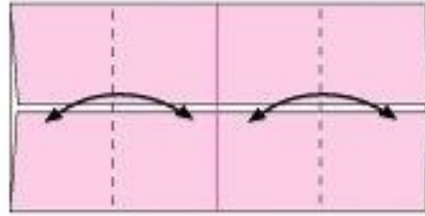

2



3

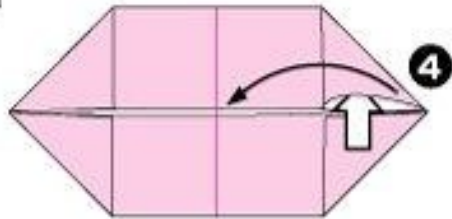

4

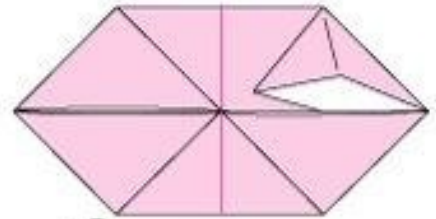

5

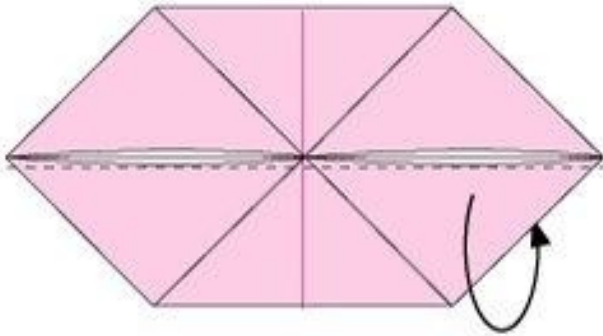

6

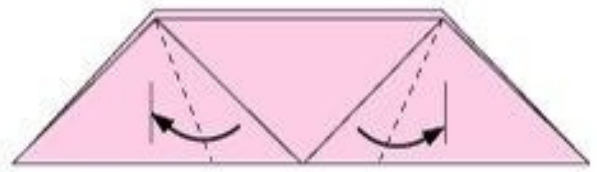

7

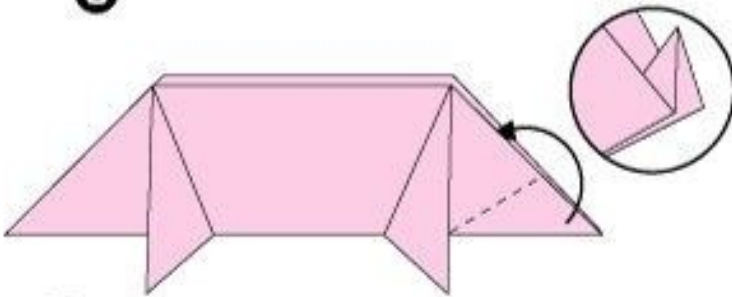

8

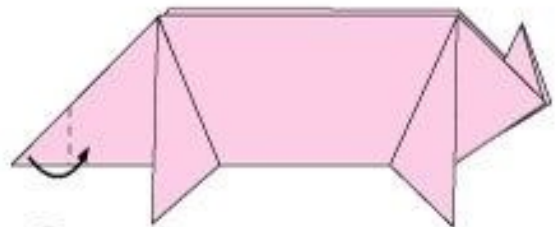

9

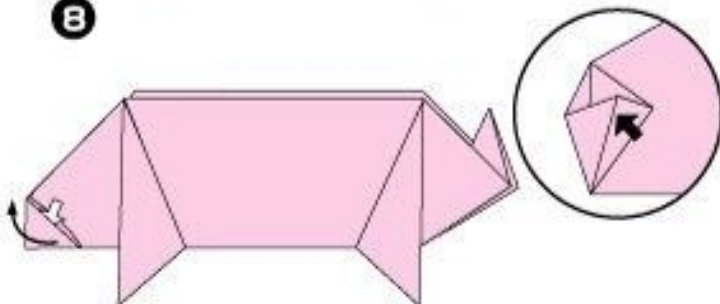

10

11

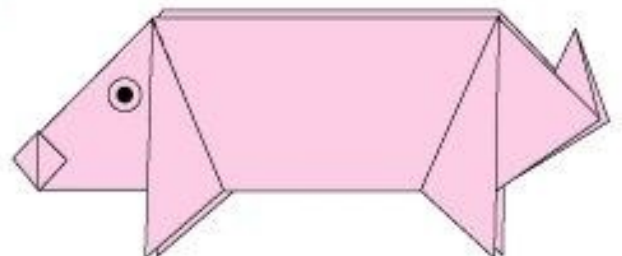



Cocotte

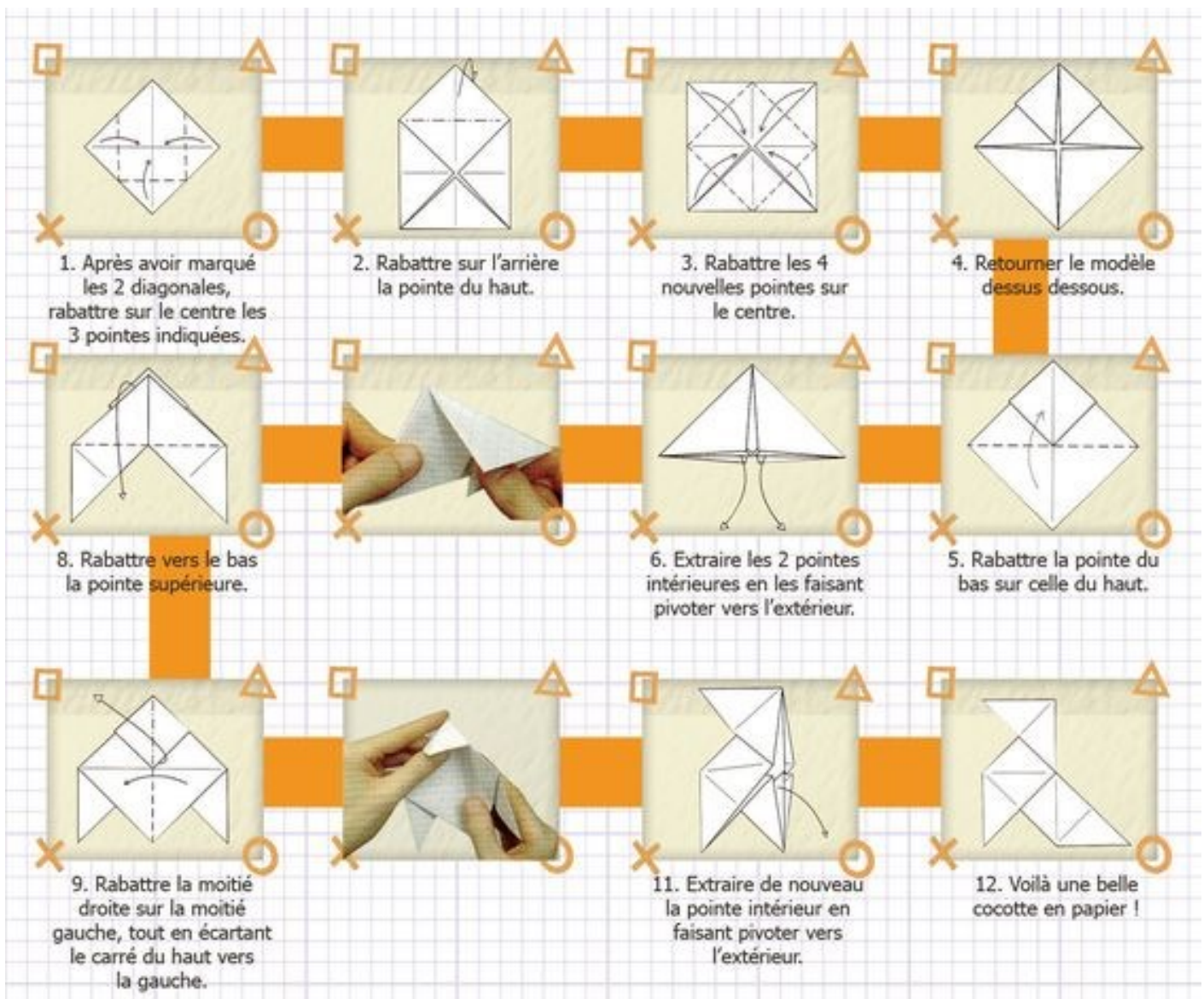



Cœur

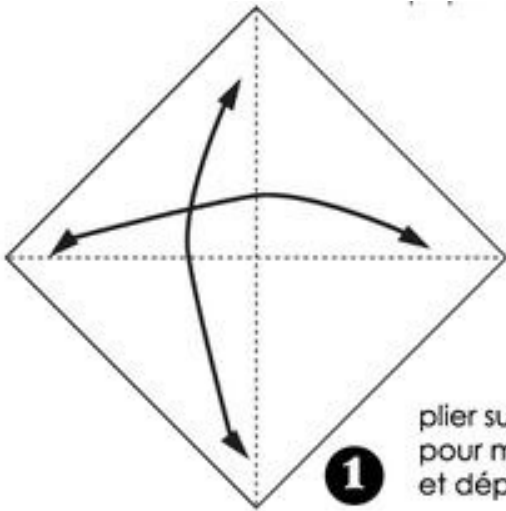

1

plier sur les pointillés pour marquer le papier et déplier

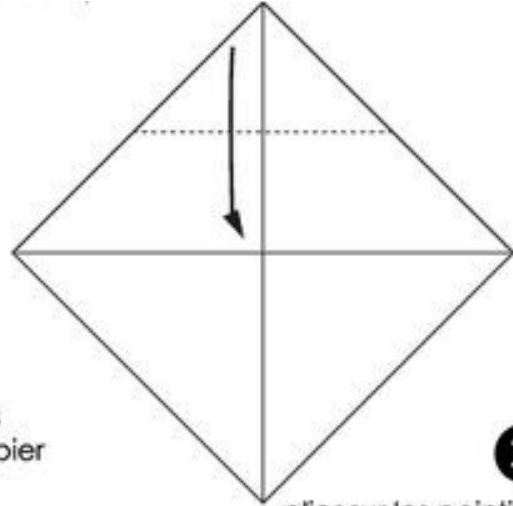

2

plier sur les pointillés

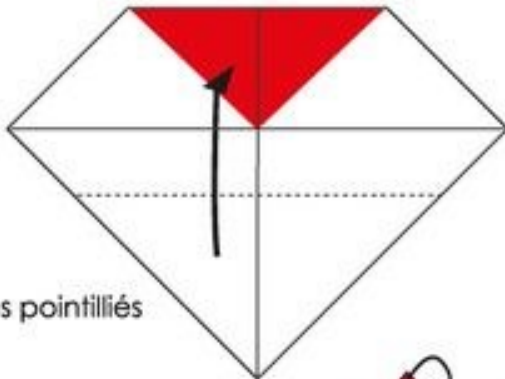

3

plier sur les pointillés

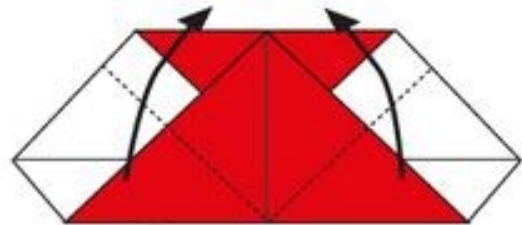

4

plier sur les pointillés

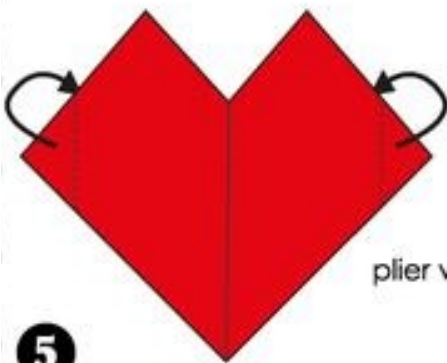

5

plier vers l'extérieur des pointillés

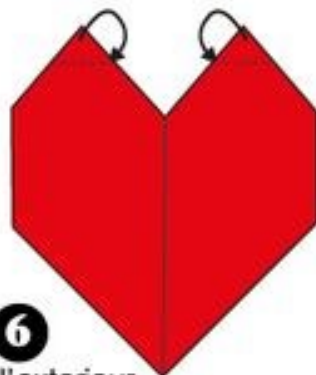

6

plier vers l'extérieur des pointillés





Colombe

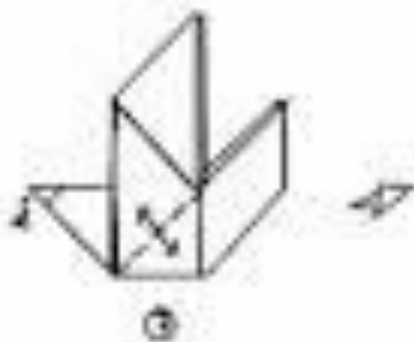
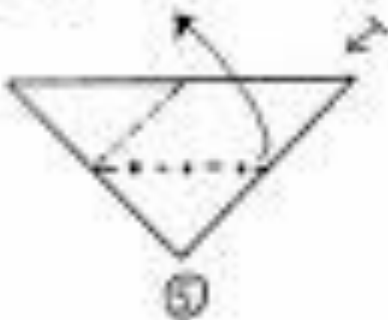
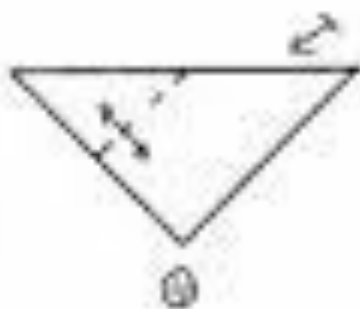
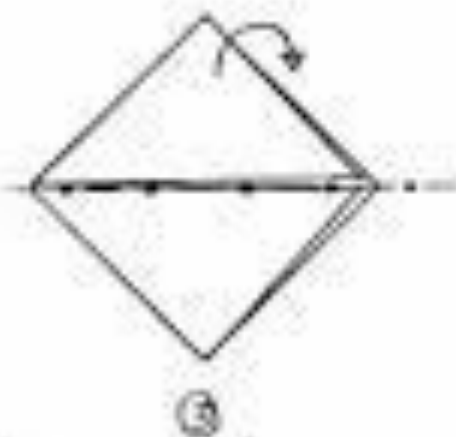
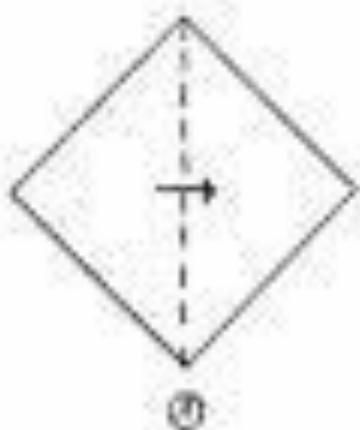



Enveloppe

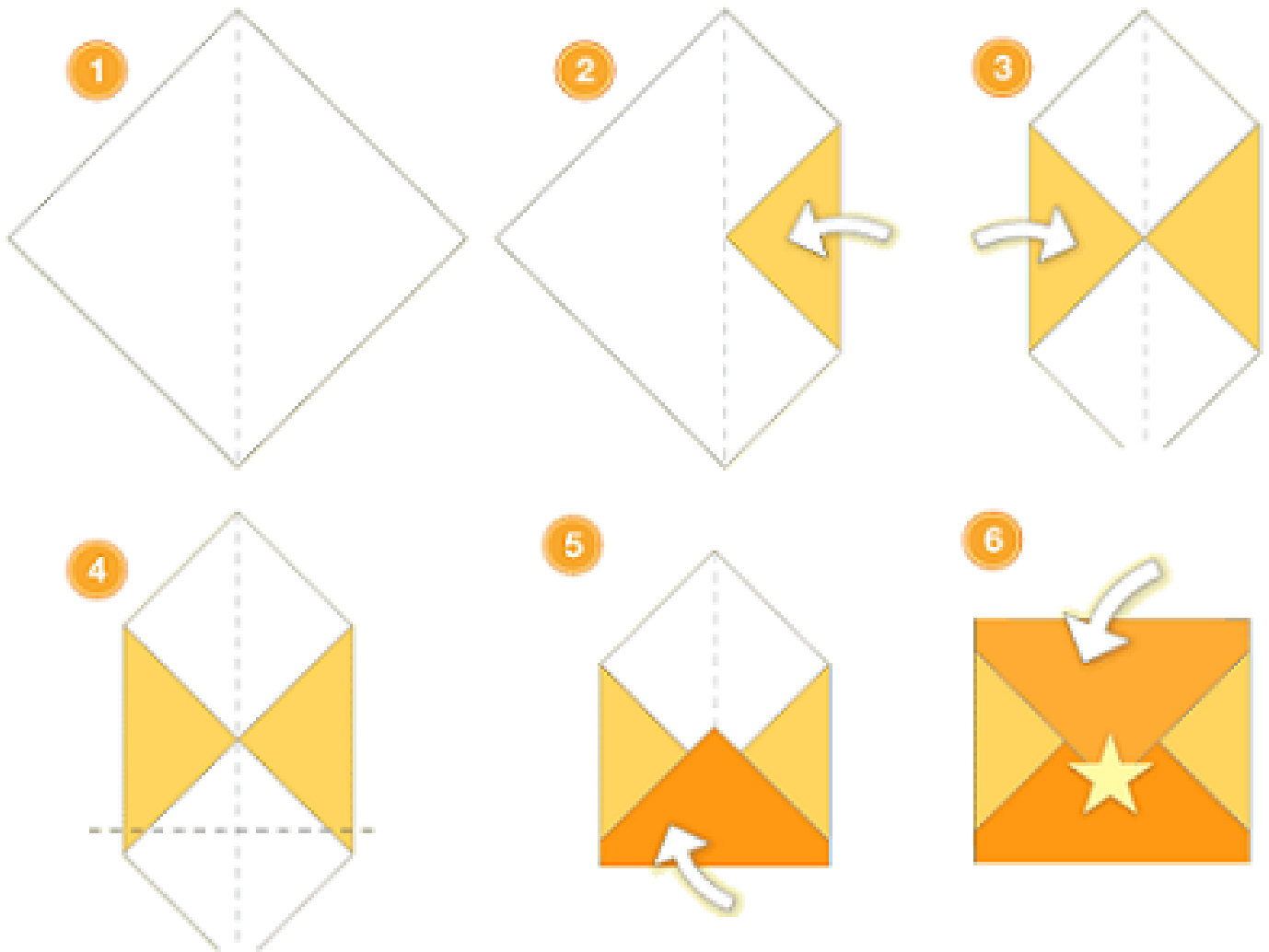



Crabe

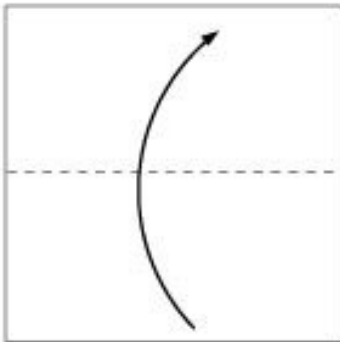

1

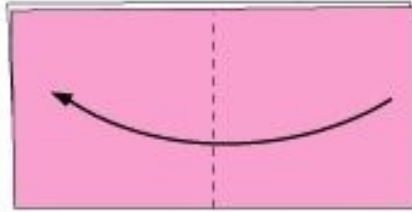

2

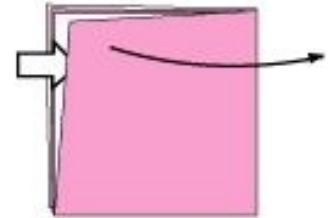

3

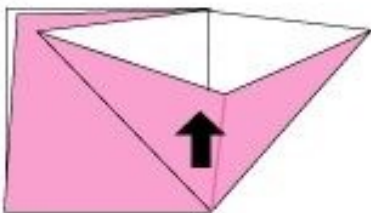

4

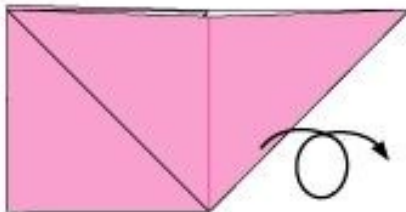

5

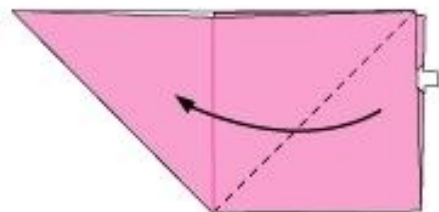

6

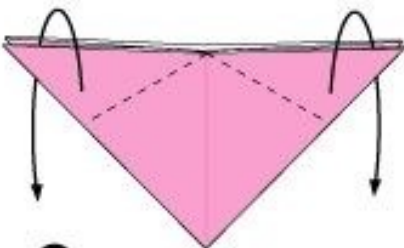

7



8

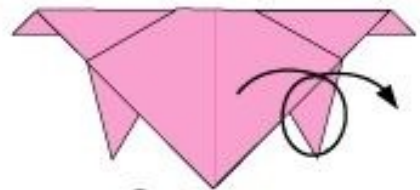

9

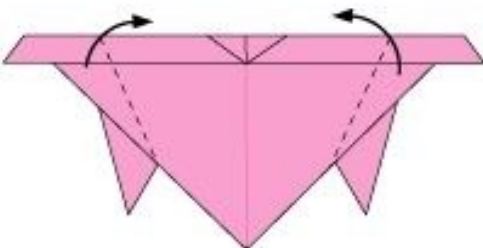

10



11



12

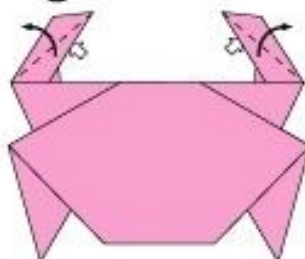

13

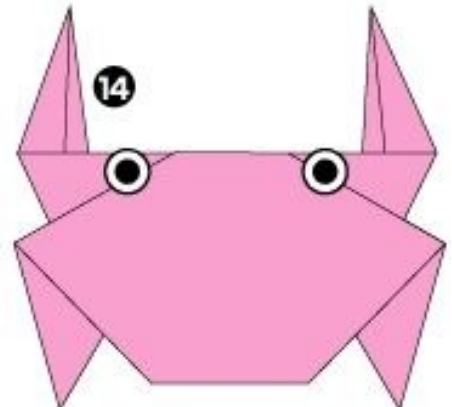

14



Escargot

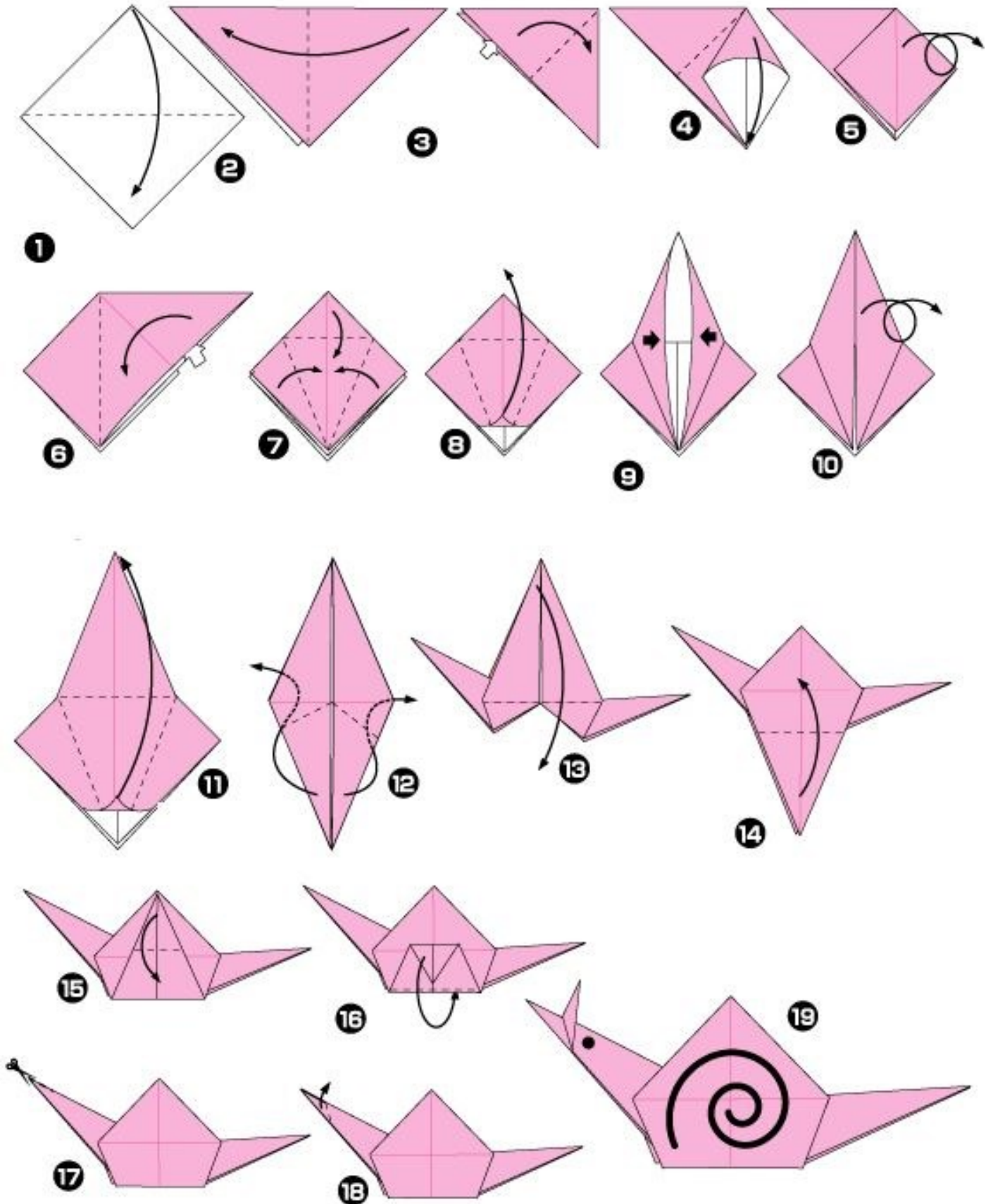



Etoile

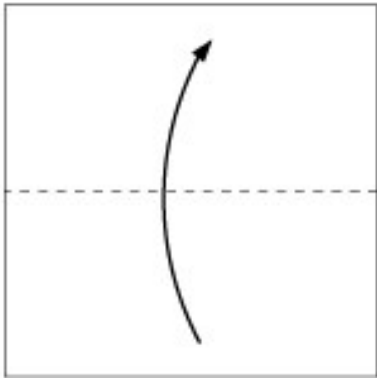

1

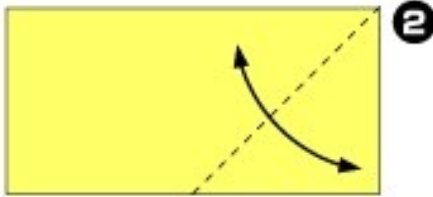

2

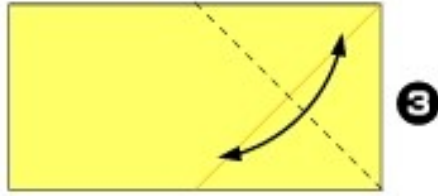

3



4

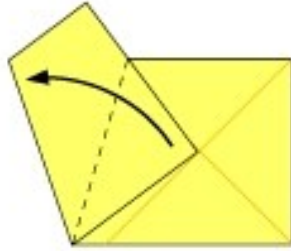

5

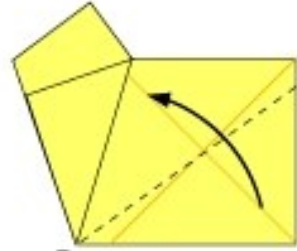

6

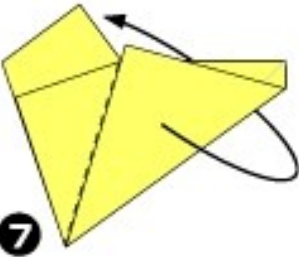

7

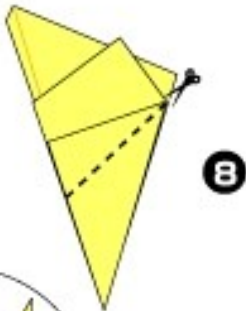

8

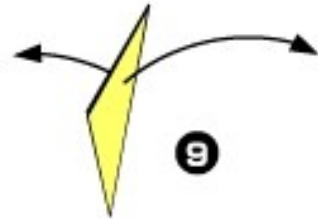

9

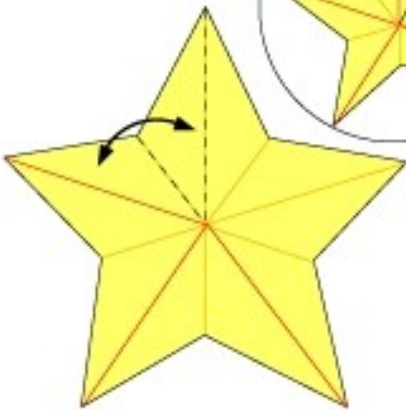

10

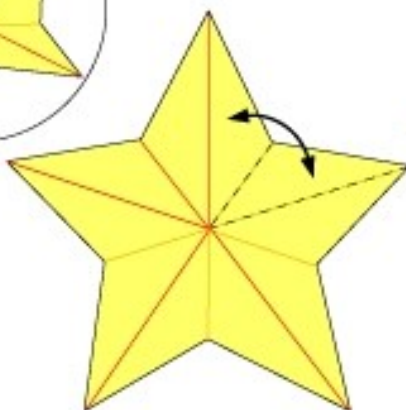

11

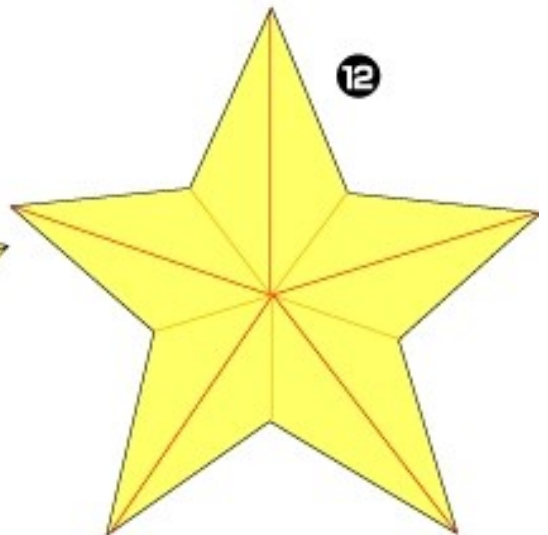

12



Fleur de lys

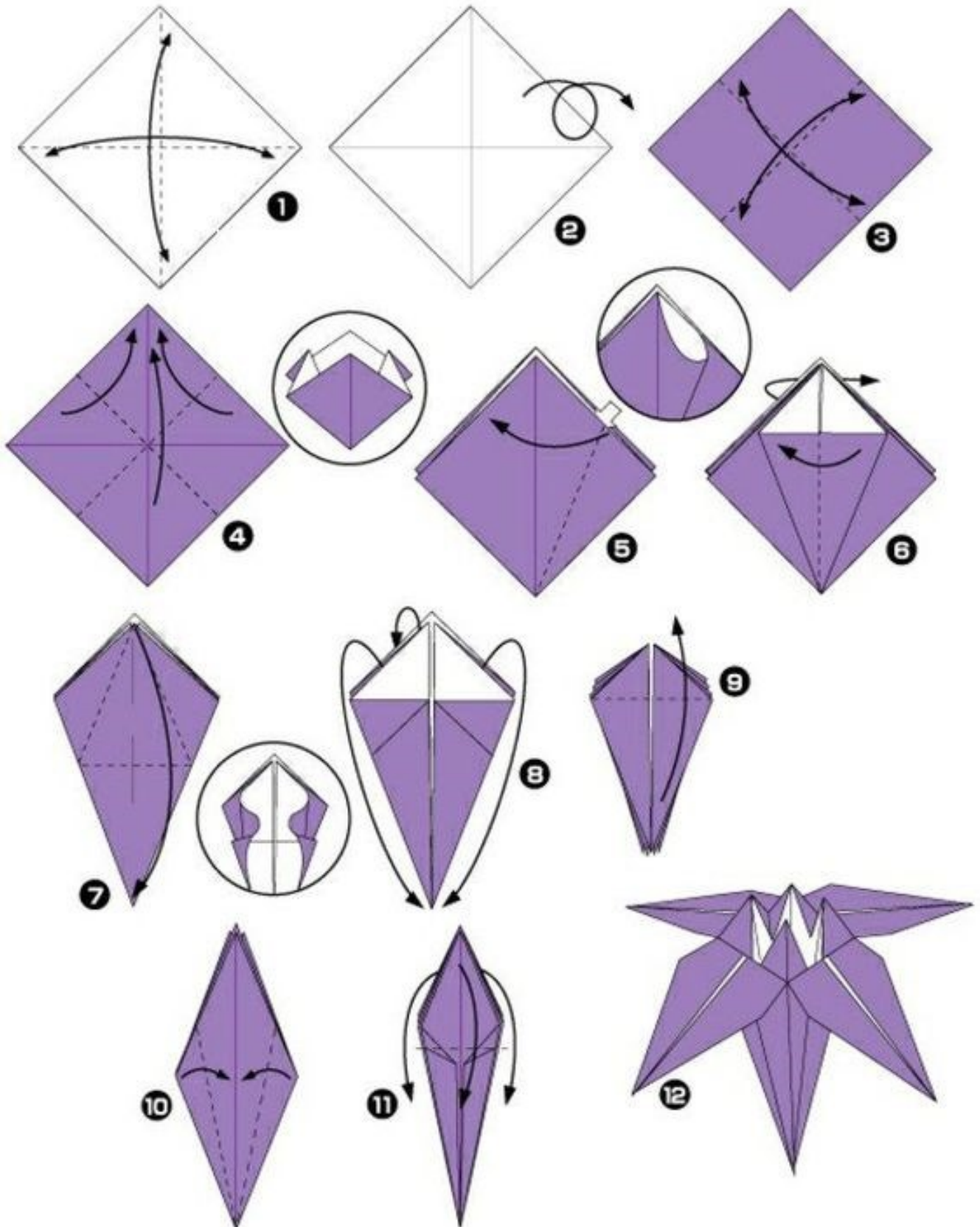



Fleur

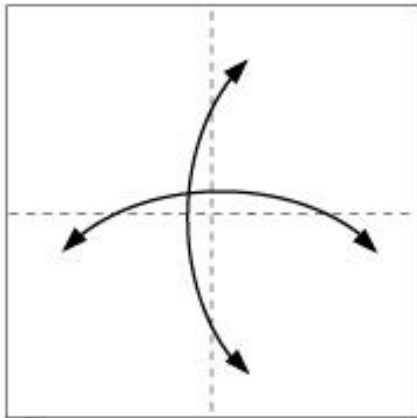

1

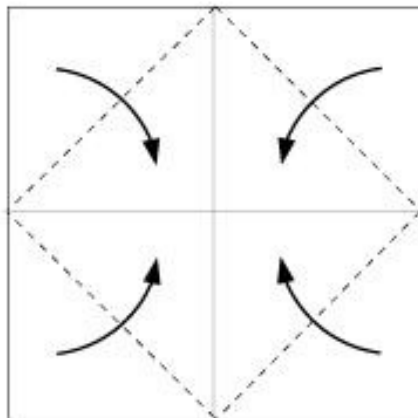

2

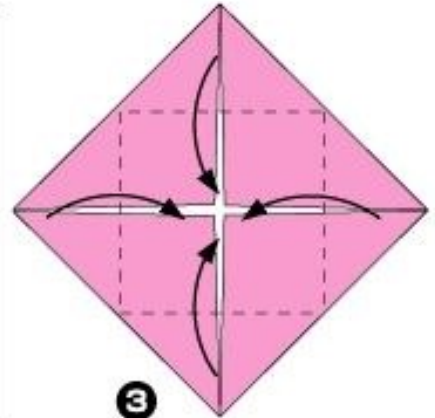

3

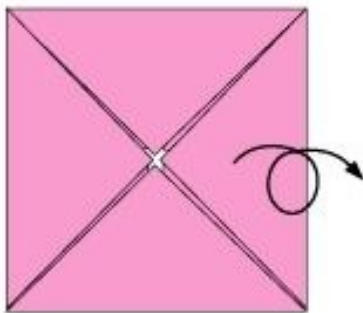

4

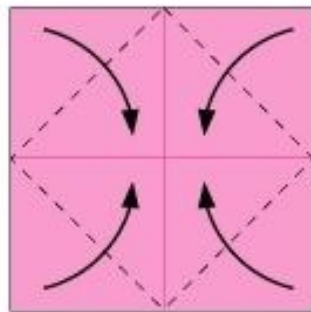

5

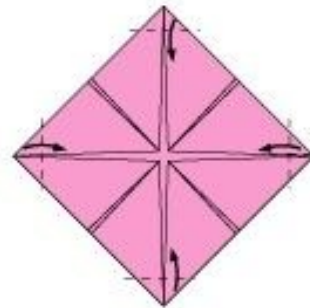

6

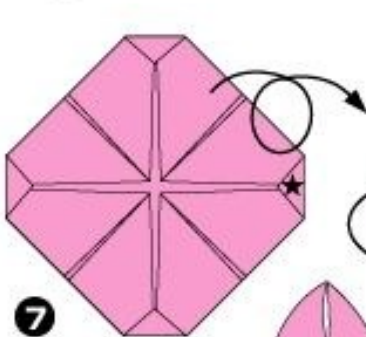

7

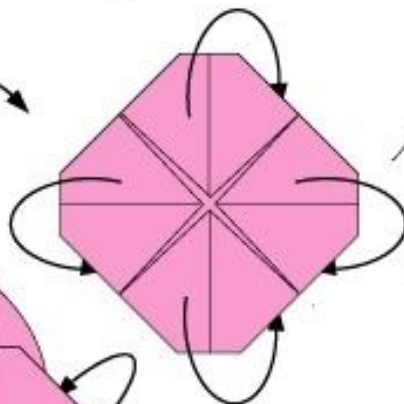

8

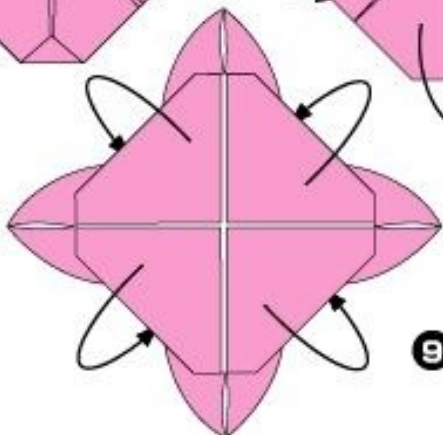
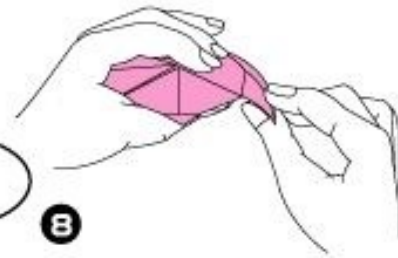

9

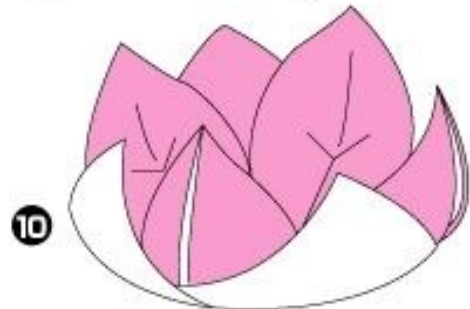

10



Fleur de cerisier

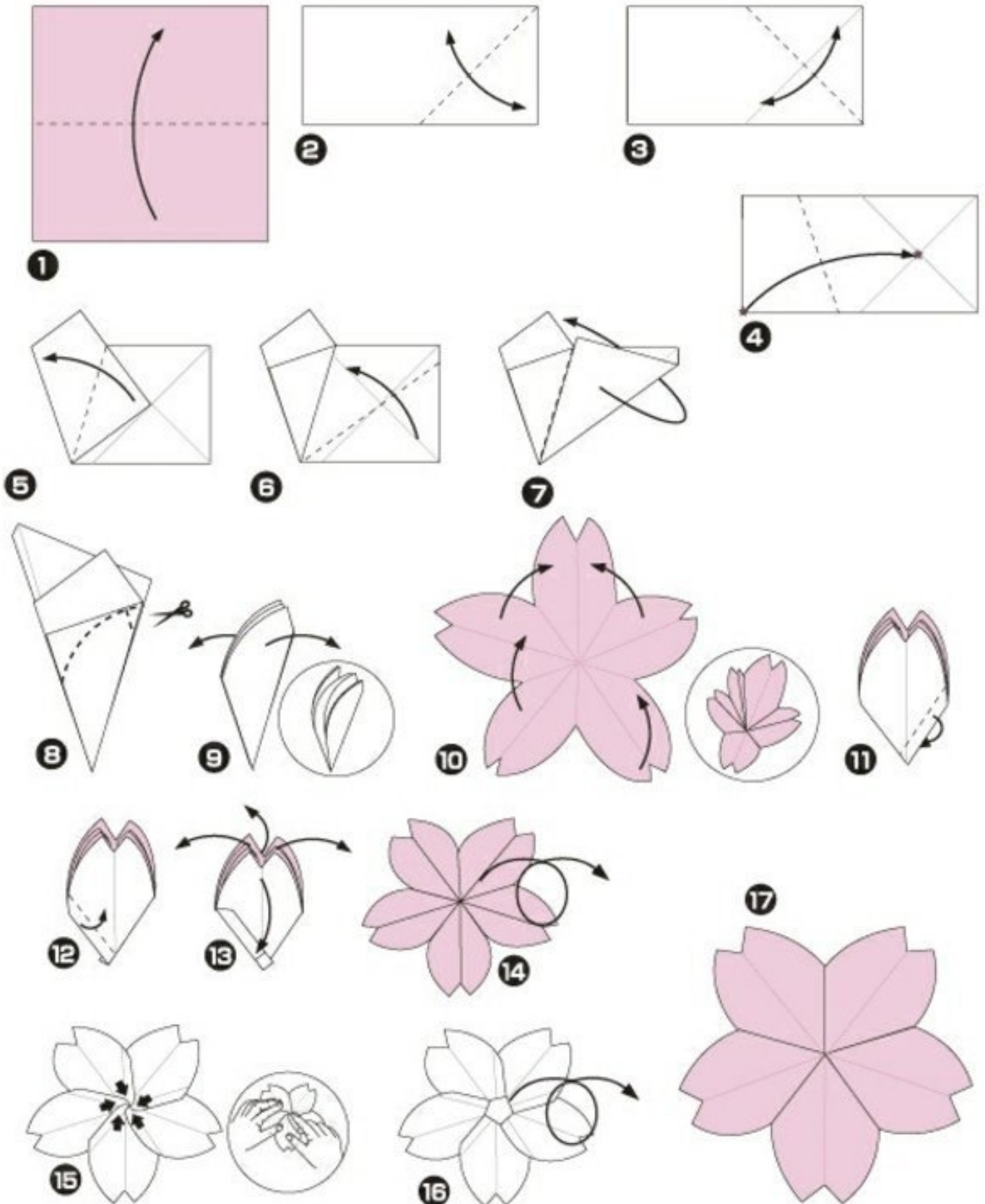



Grenouille

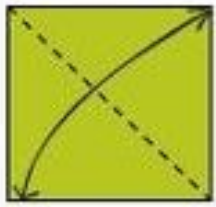

①



②

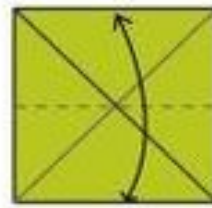

⑤



⑥

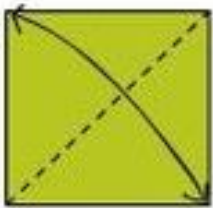

③



④

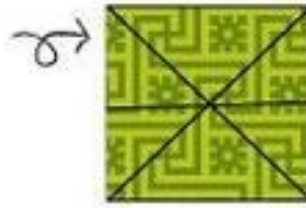

⑦



⑧

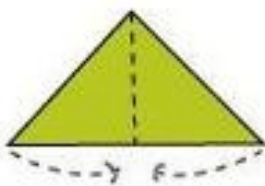

⑨



⑩



⑪

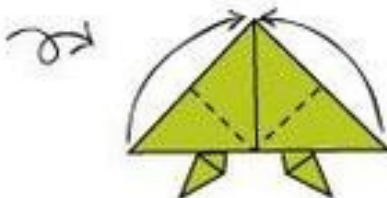

⑫



⑬



⑭



⑮



⑯



⑰



Grue

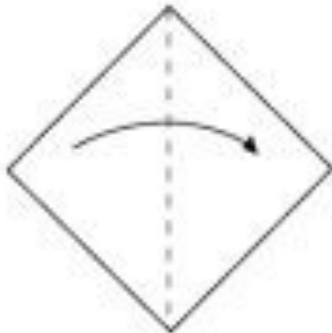

1° Pliez une feuille carrée en 2, en suivant le diagonale

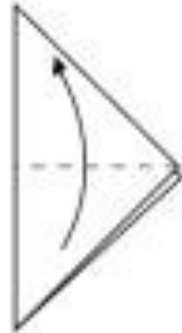

2° Pliez la pointe en 2 selon le hauteur de l'hypoténuse

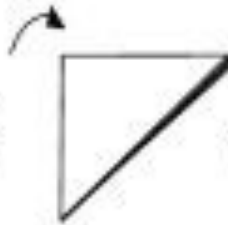

3° Courbez le triangle supérieur et aplatissez-le en forme de carré

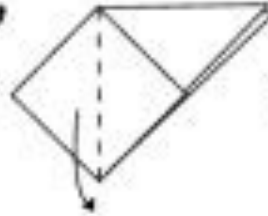

4° Retournez l'objet et appliquez le deuxième triangle



5° Retournez vers le milieu les rebords supérieurs droit et gauche, vers le dessous



6° Retournez l'objet et recommencez l'opération de l'autre côté



7° Pliez vers le bas le triangle du bas, pour relâcher



8° Ce vers les rebords supérieurs. Tracez les marques en pointillé sur le dessus pour le vers le point de bas vers le bas, pour obtenir un losange.

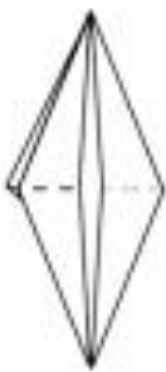
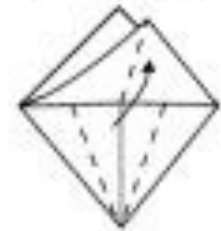

9° Recommencez la même opération au dos

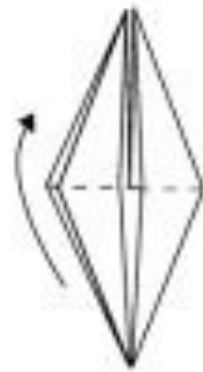

10° Tournez le losange à 180°



11° Retournez les angles vers la ligne centrale, en suivant les pointillés



12° Recommencez la même opération au dos



13° Retournez le pliage l'écartez des plis en remontant les pointes et en suivant les pointillés



14° Courbez vers le côté et pliez pour que les pointes s'alignent à l'intérieur du corps de l'oiseau, à 45°

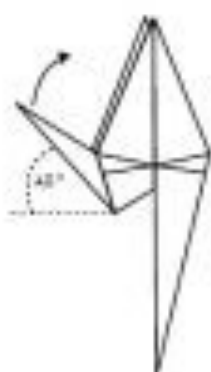

15° Retournez une des pointes vers l'arrière et pour former le bec de l'oiseau



16° Tirez les rebords vers le bas pour les ouvrir et gonfler le corps de l'oiseau



Lapin

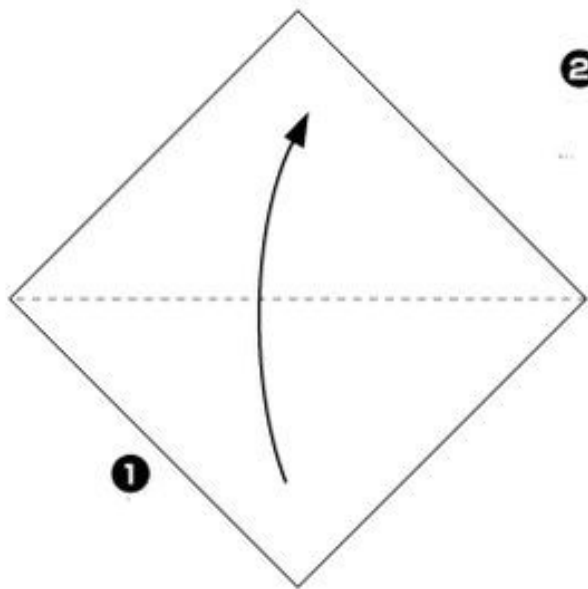

2

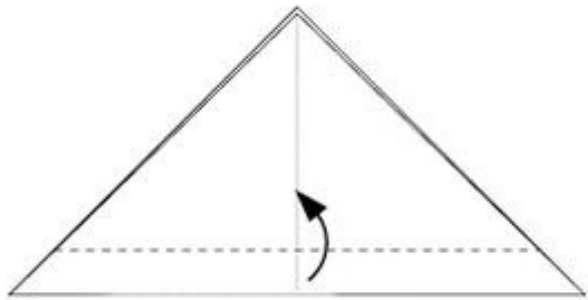
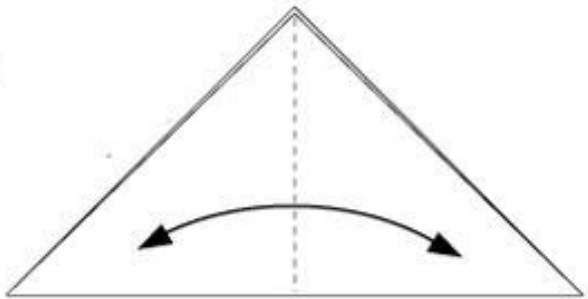

3

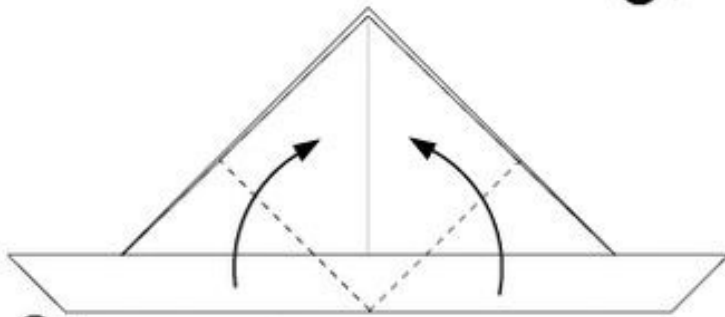

4

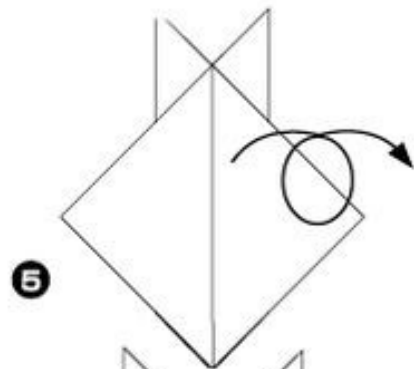

5

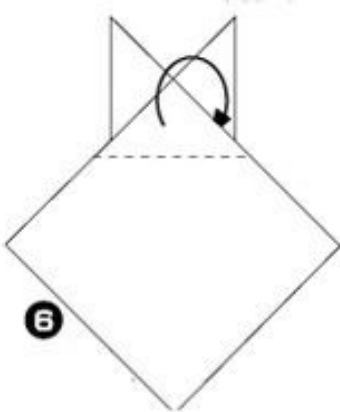

6

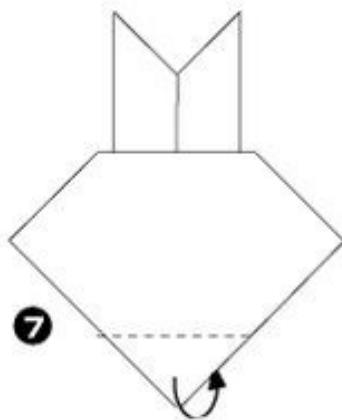

7

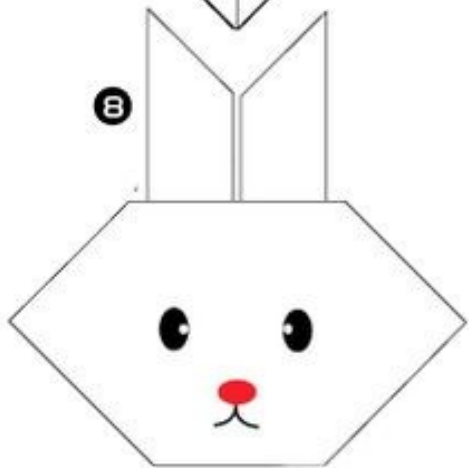

8



Lion

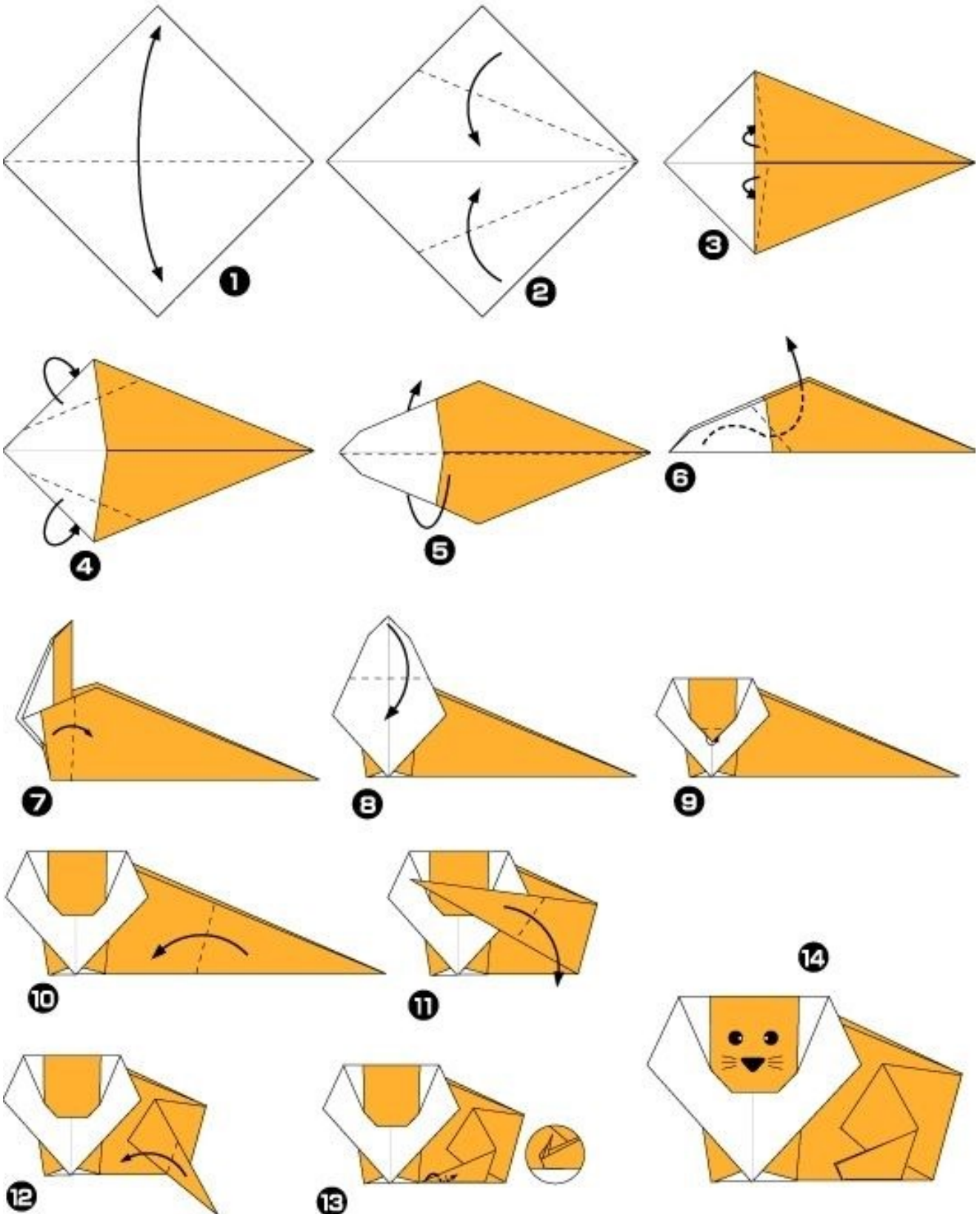



Manchot

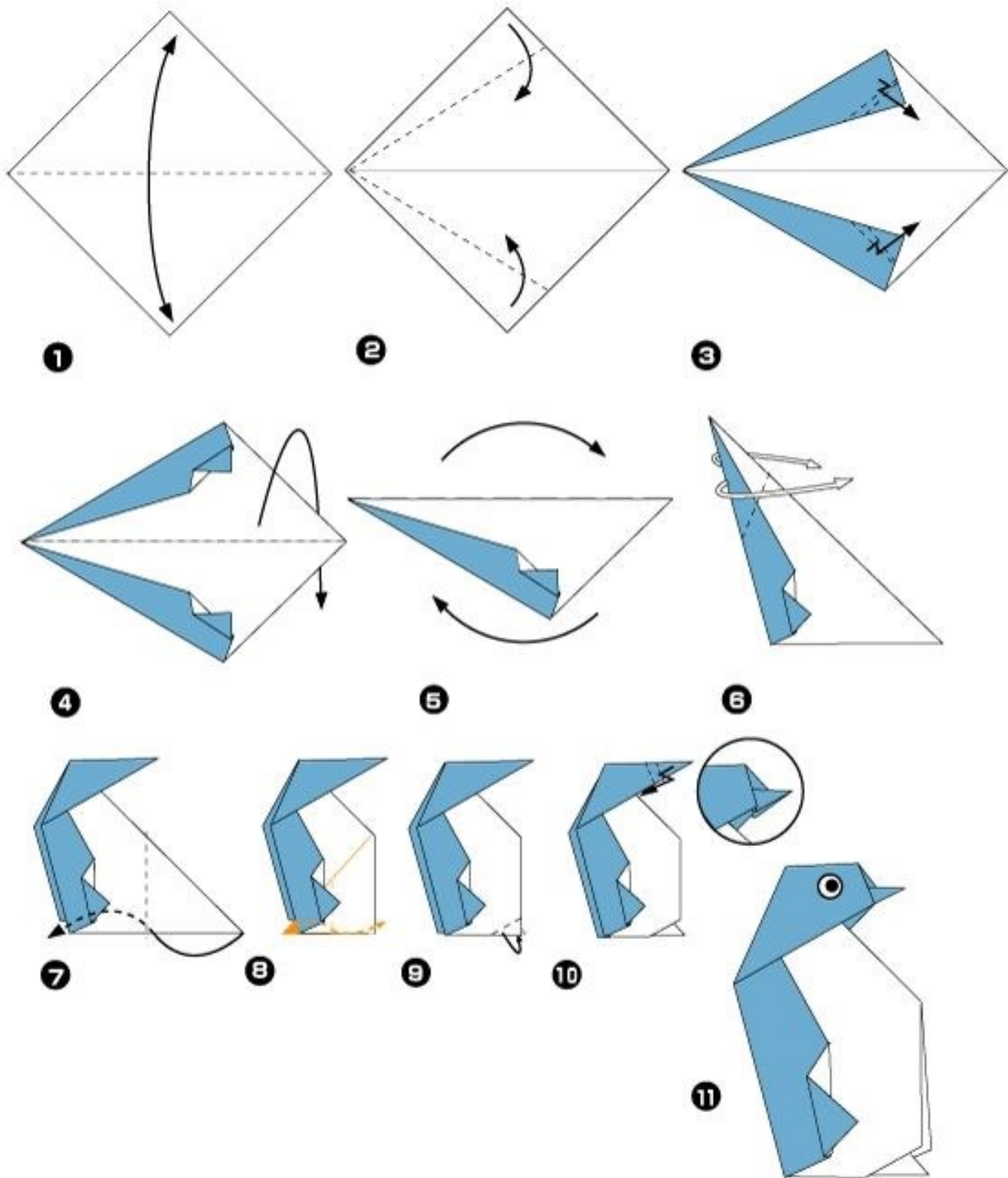



Marque-page

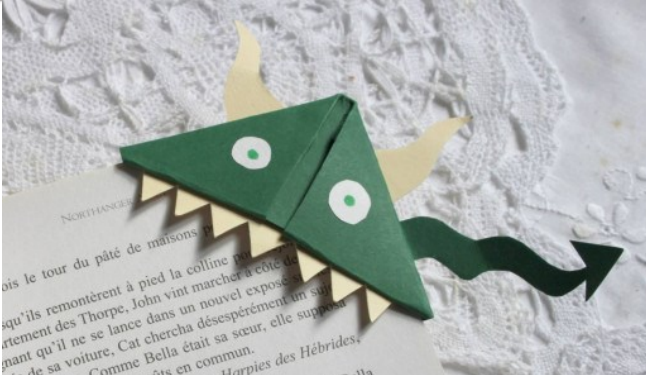
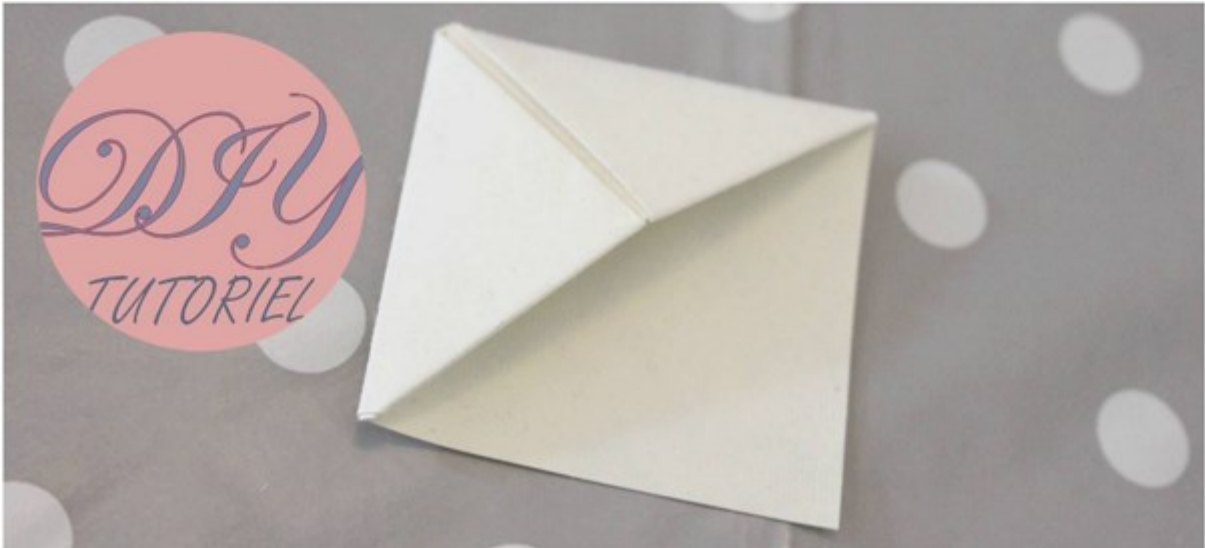
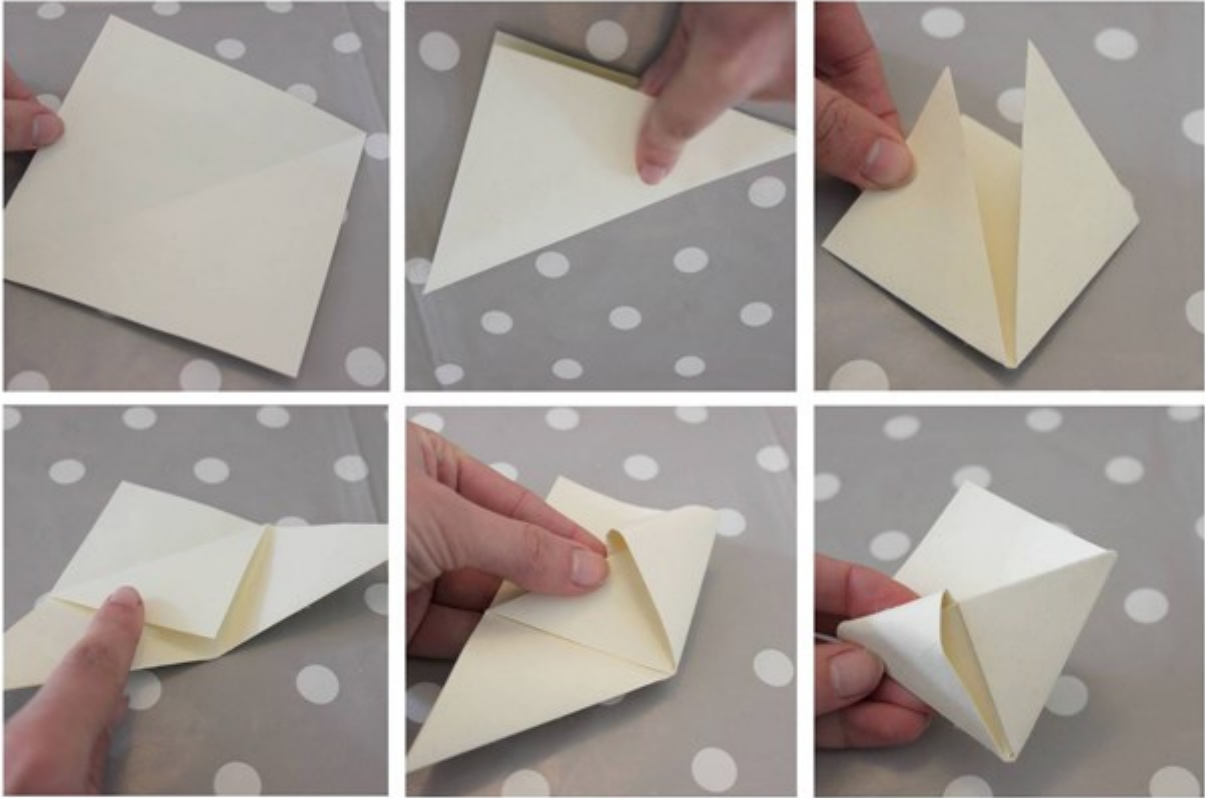



Moulin à vent

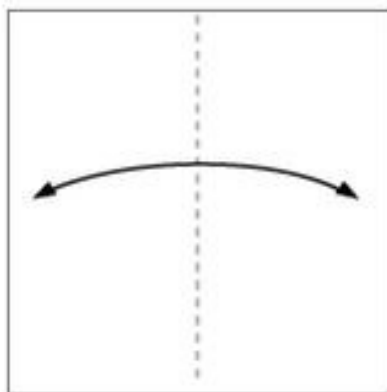

1 Pliez-en deux pour marquer le pli

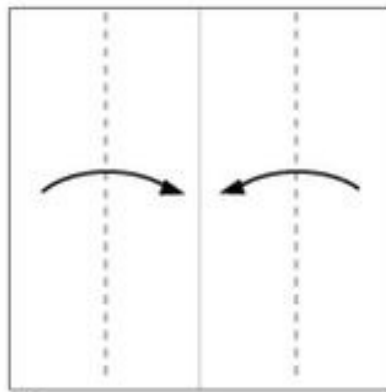

2 Pliez vers le centre de la feuille

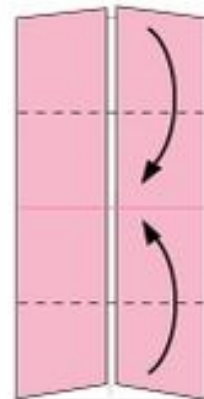

3 Pliez sur les pointillés

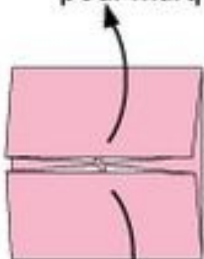

4 Marquez le pli

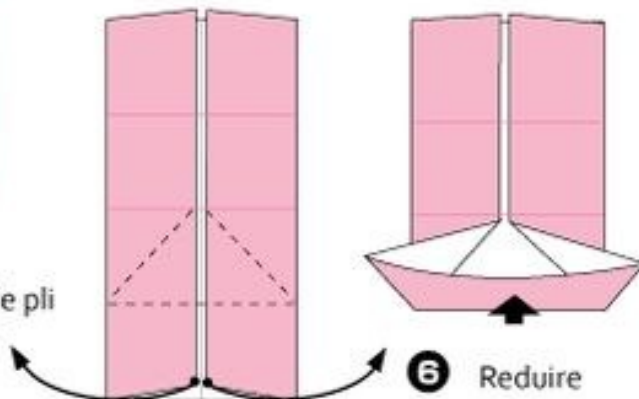

5 Abra sobre ↑ y recúbralo

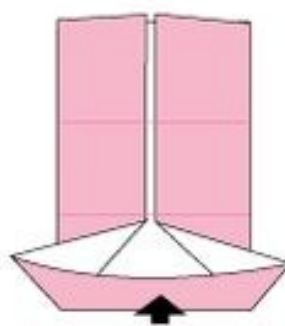

6 Reduire

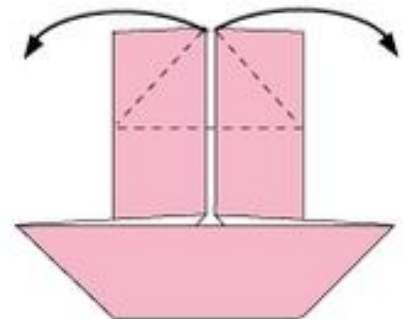

7 Répétez les autres côtés

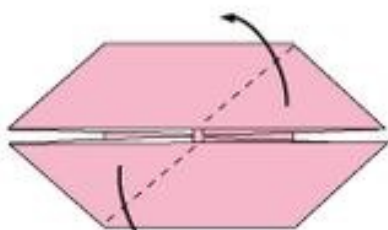

8 Pliez sur les pointillés

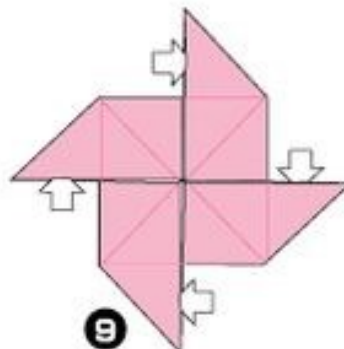

9 Ouvrez

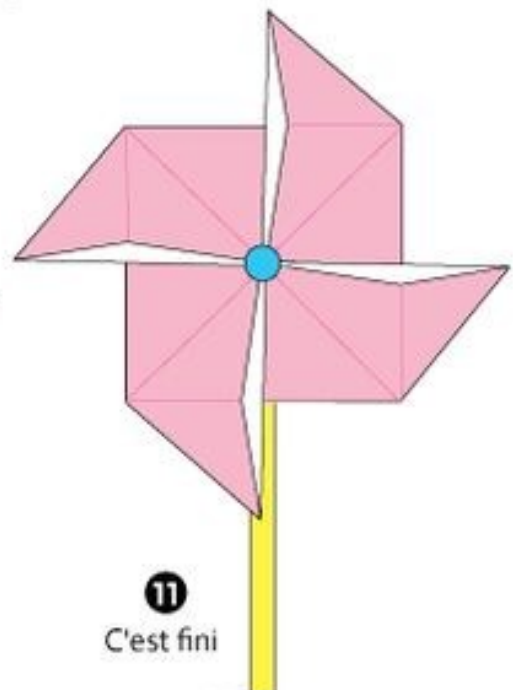

11 C'est fini

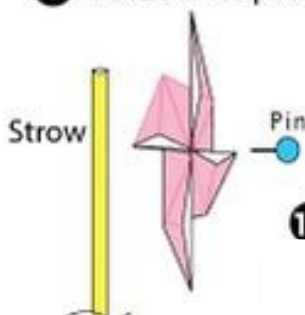

10 Baton une epingle

Navette spatiale

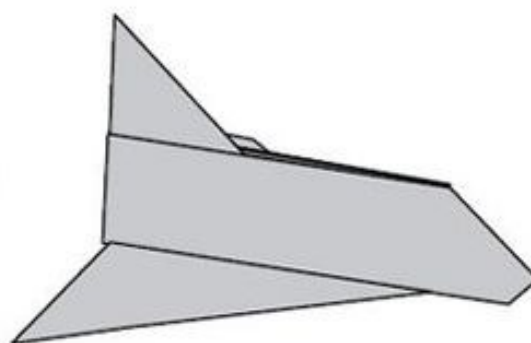
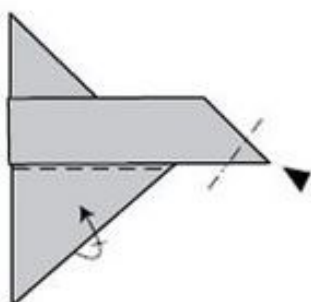
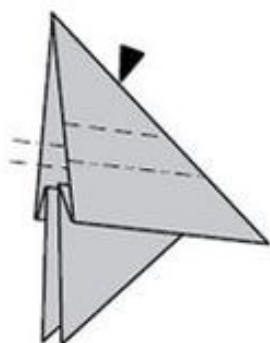
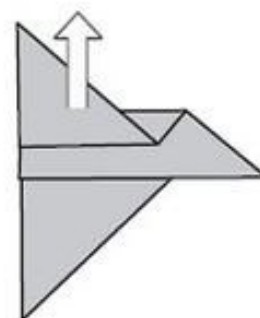
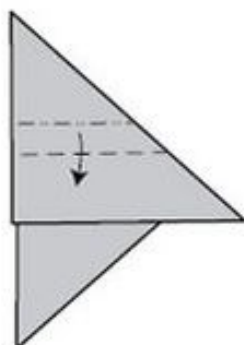
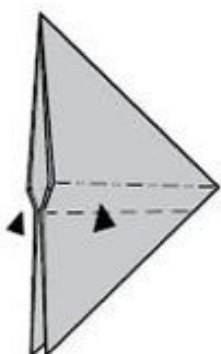
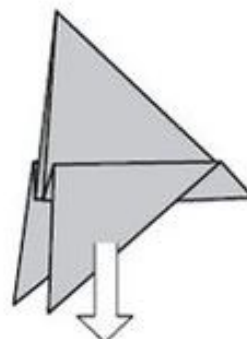
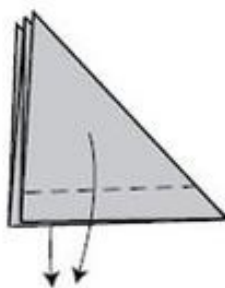
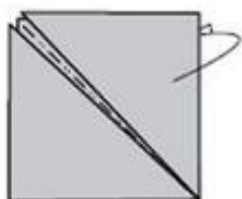
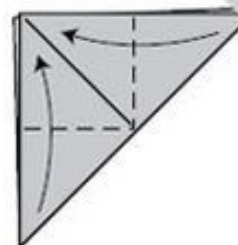
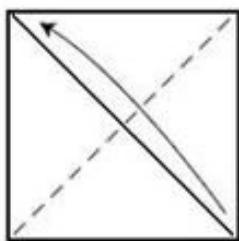
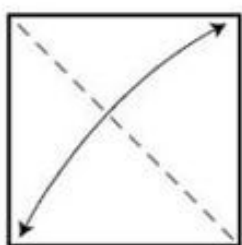
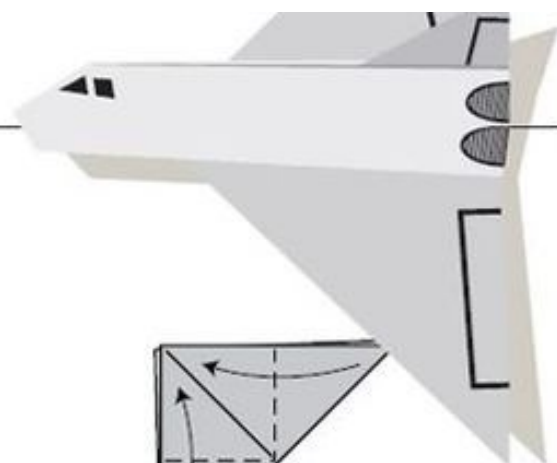



Ours

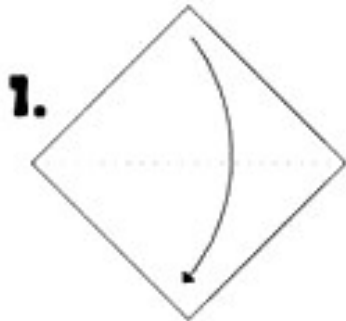

1. Plier la Feuille en deux

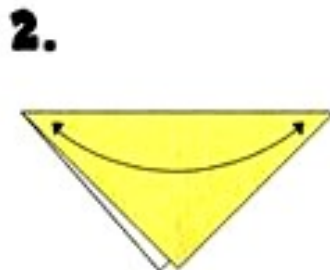

2. Plier la Feuille en deux et remettre comme avant. Cette opération sert à tracer le pli.

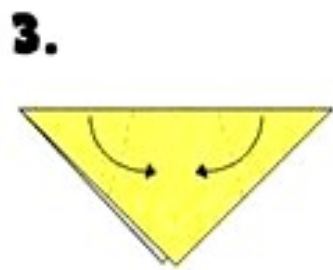

3. Plier en suivant les pointillés

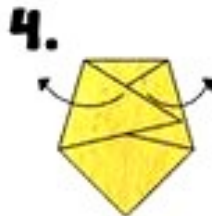

4. Plier en suivant les pointillés



5. Plier en suivant les pointillés. (regarder image suivante)



6. Retournez votre origami



7. Plier en suivant les pointillés



8. Plier la partie du haut et celle du bas vers l'intérieur en suivant les pointillés (regarder la fiche)



Décorez avec des crayons pour ajouter les yeux le nez et la bouche. C'est fini BRAVO!



Papillon

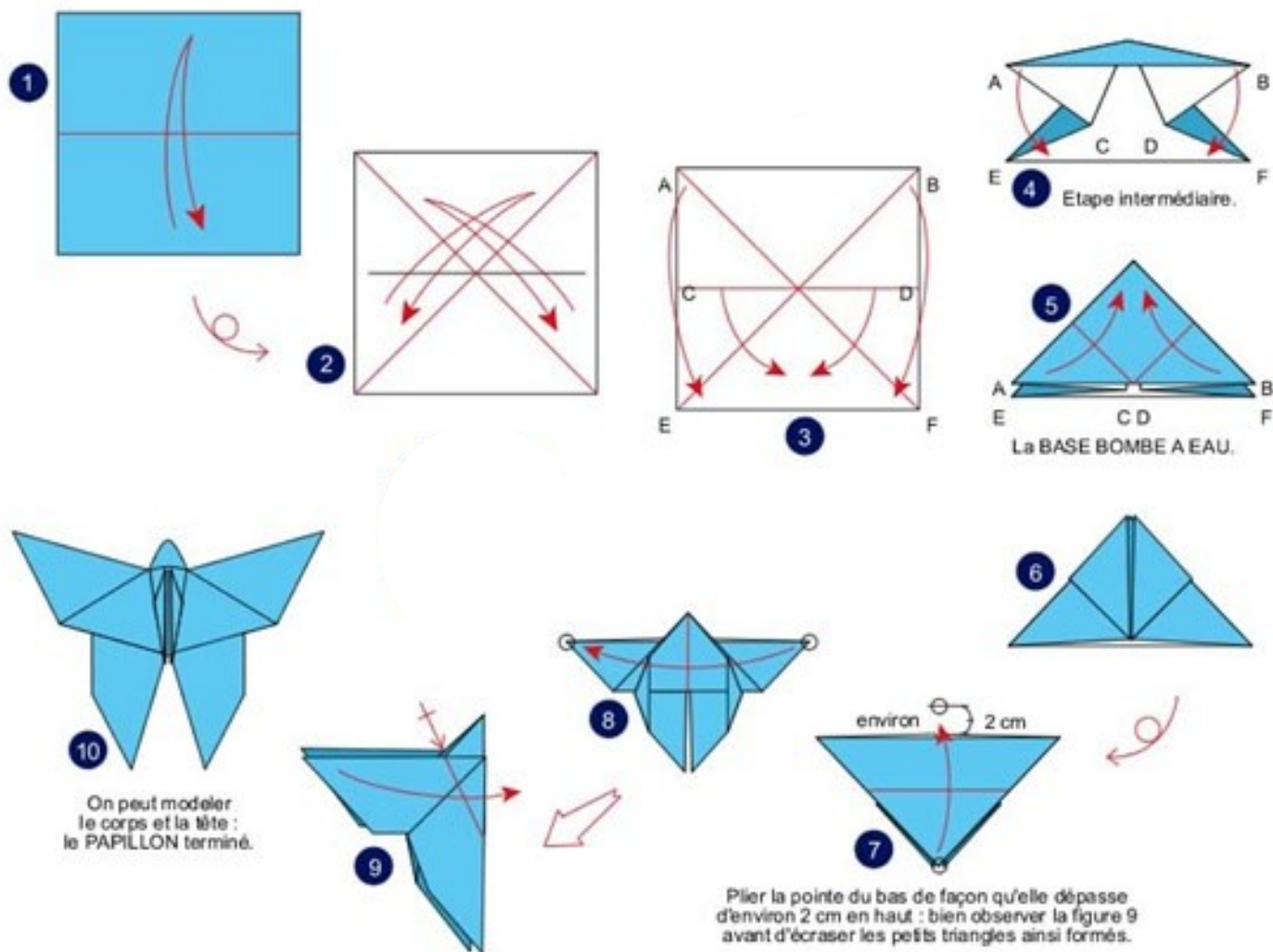



Penguin

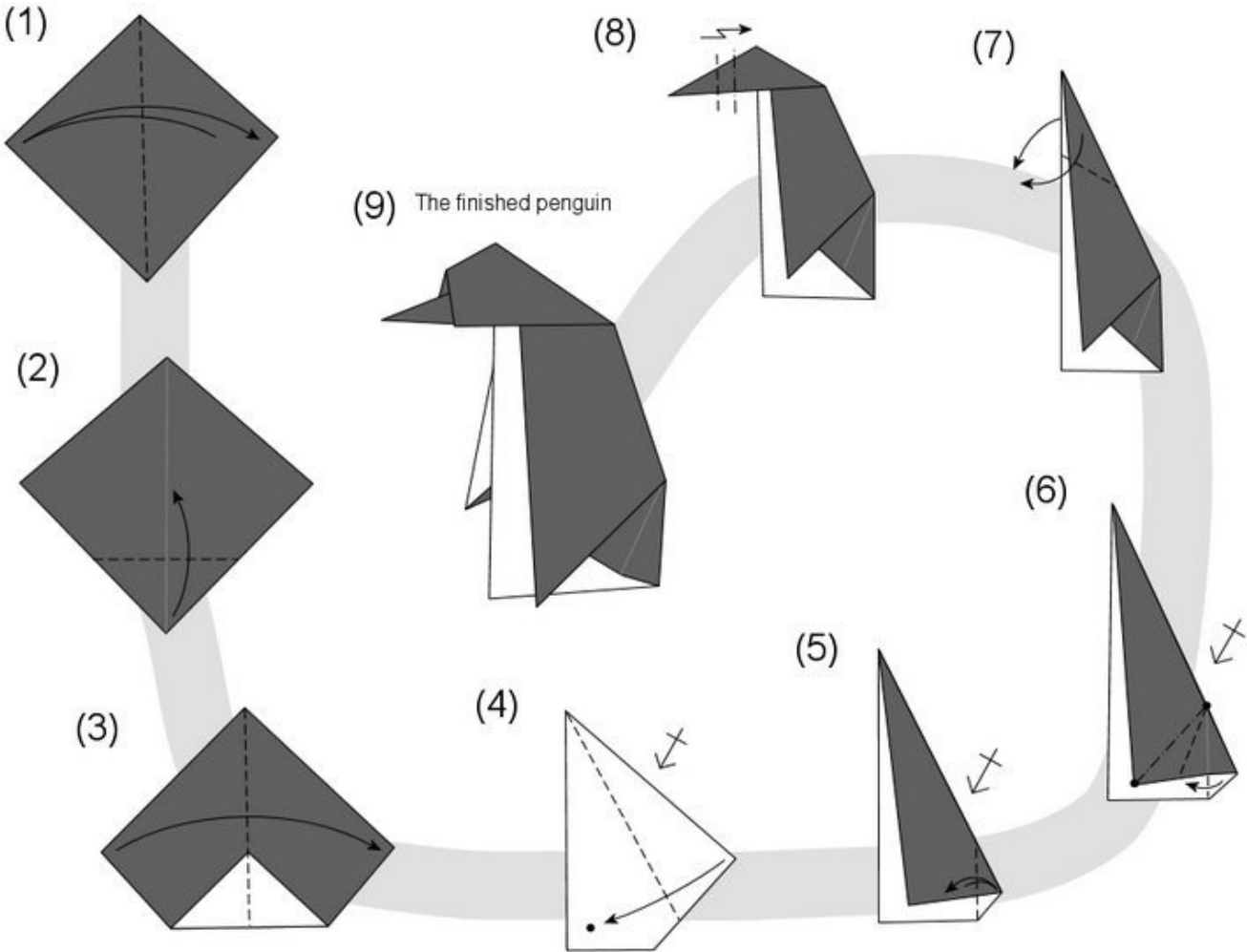

Poisson

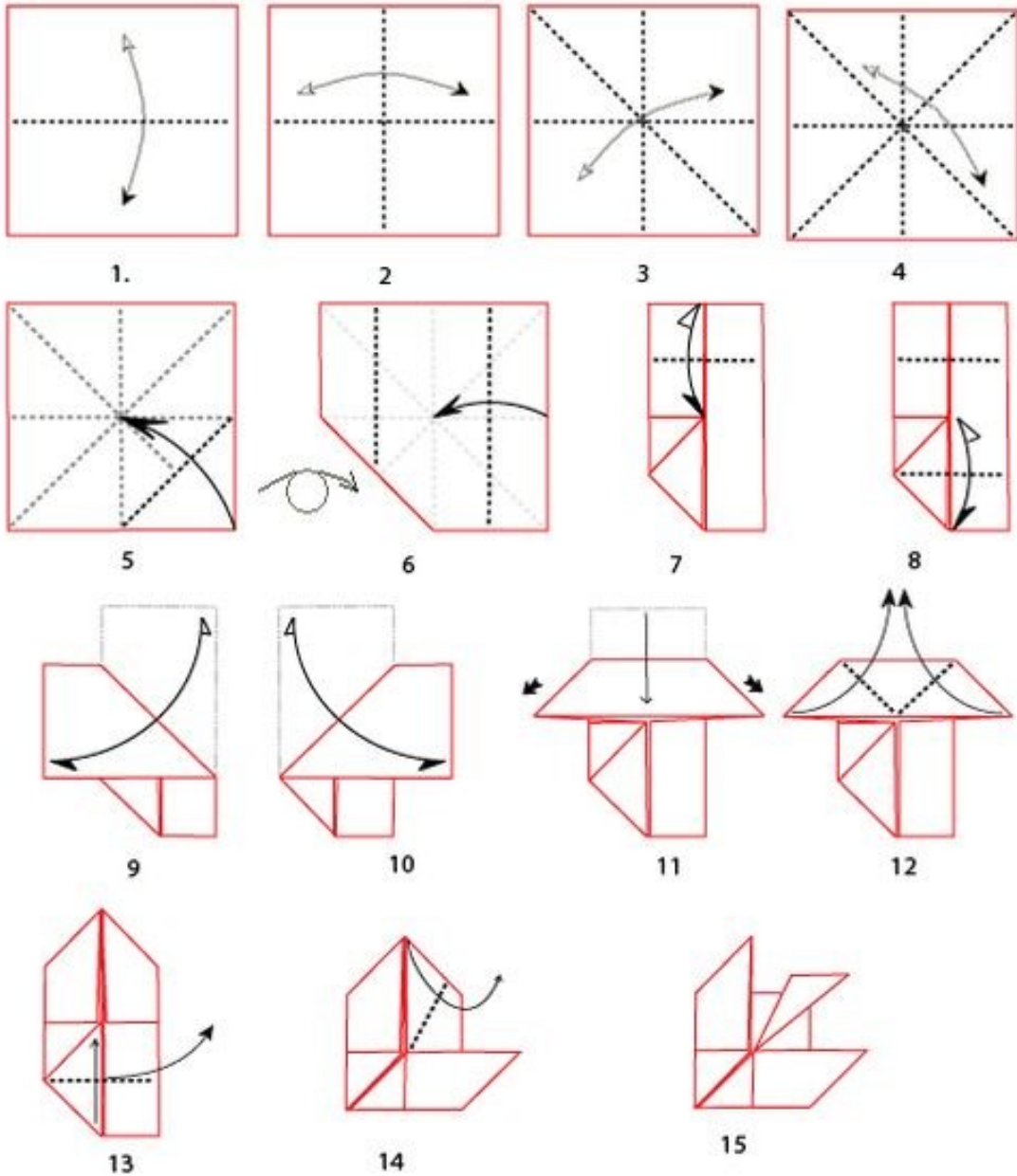

- Plier et déplier pour marquer
- Retourner le travail
- Tirer
- Plier vers l'avant
- Plier vers l'arrière
- Ouvrir
- Pousser
- Faire pivoter le travail

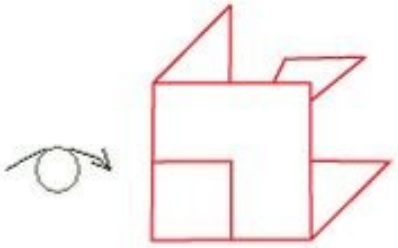



Poisson

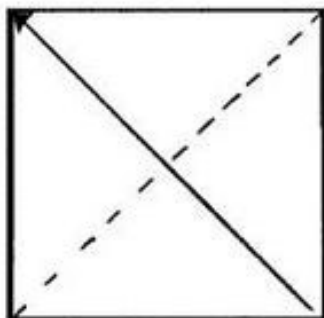

①

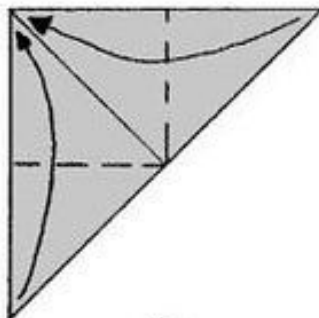

②

2

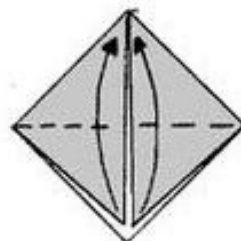

③

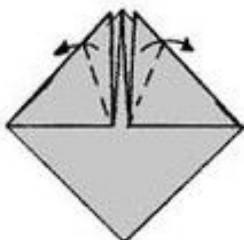

④

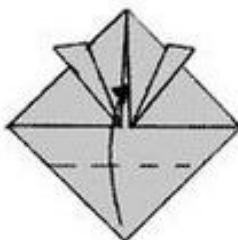

⑤

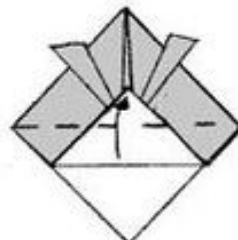

⑥

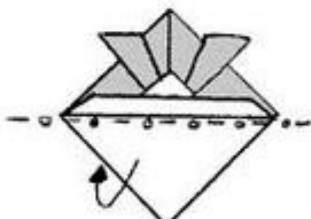

⑦

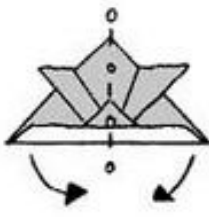

⑧

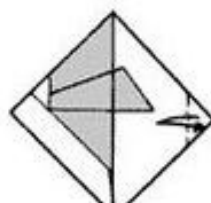

⑨

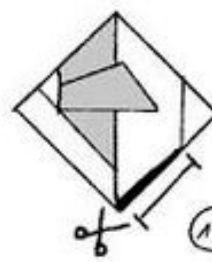

⑩

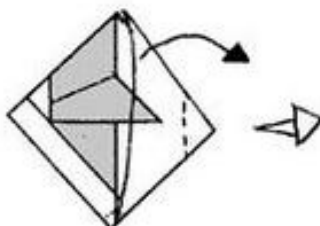

⑪

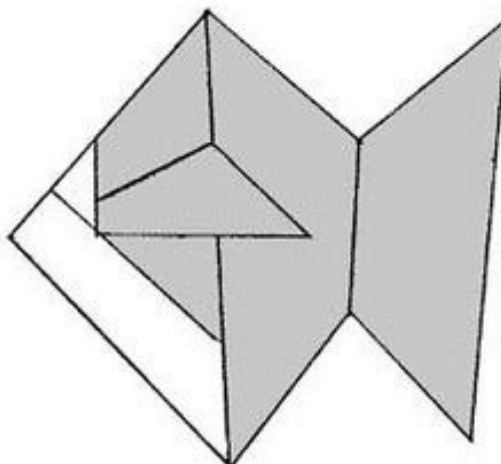



Poule

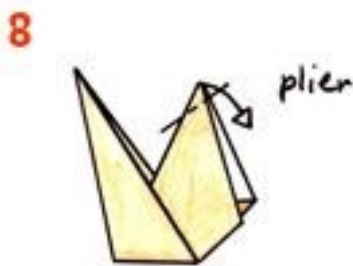
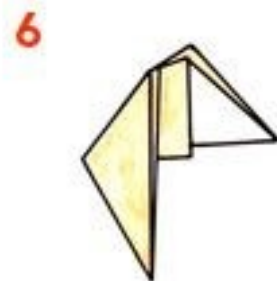
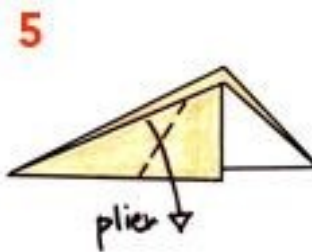
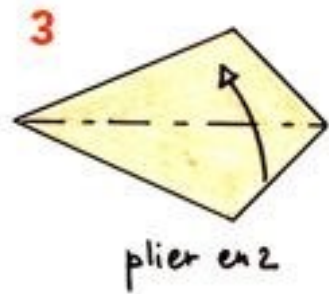
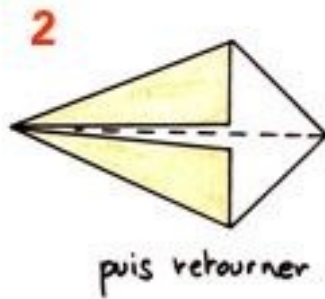
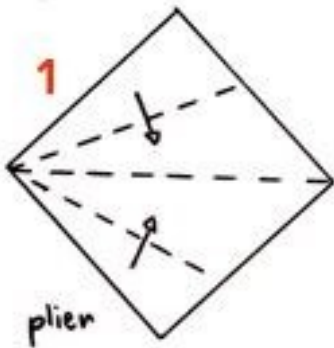
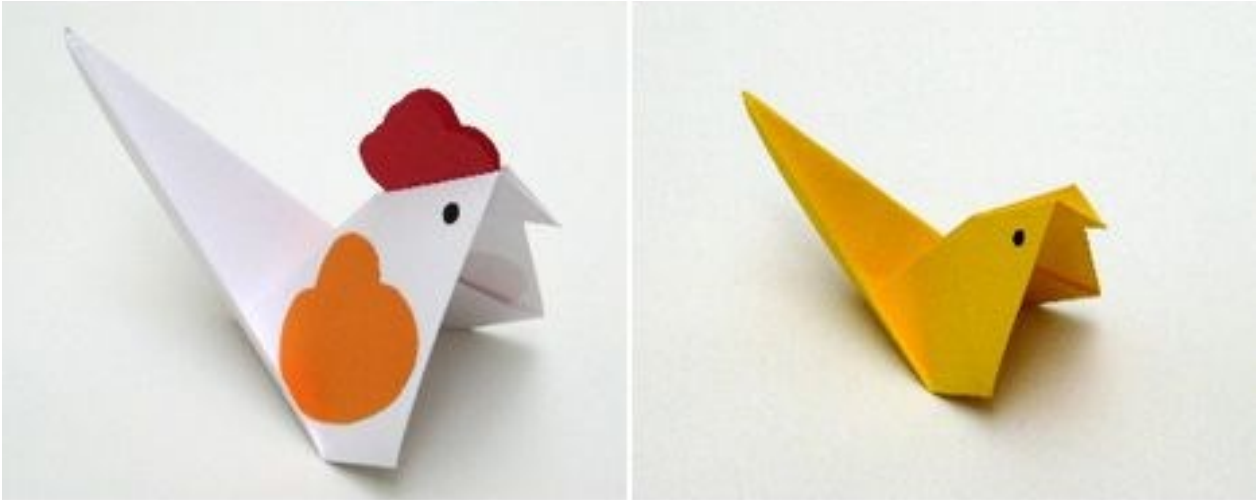



Raton-laveur

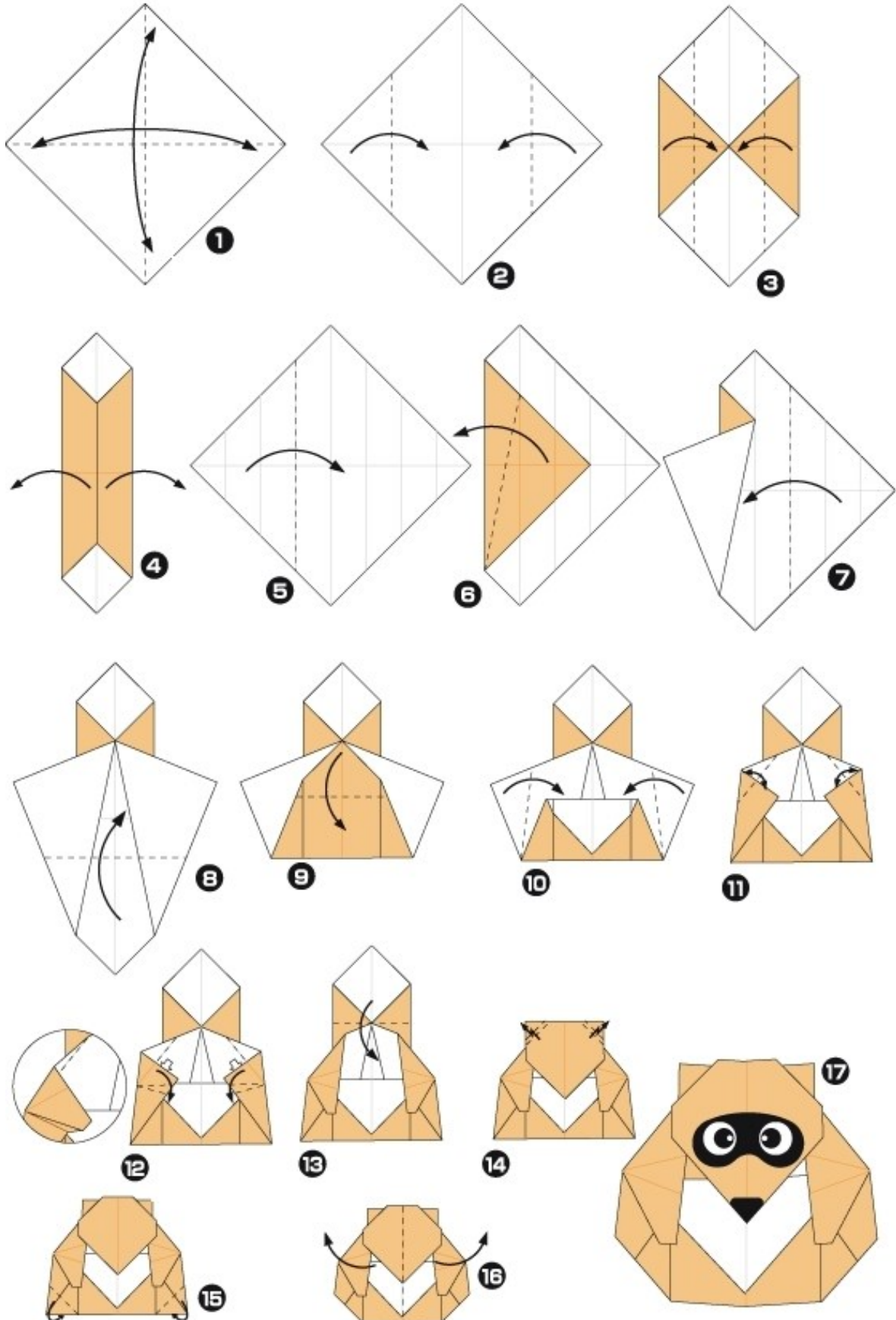



Sapin

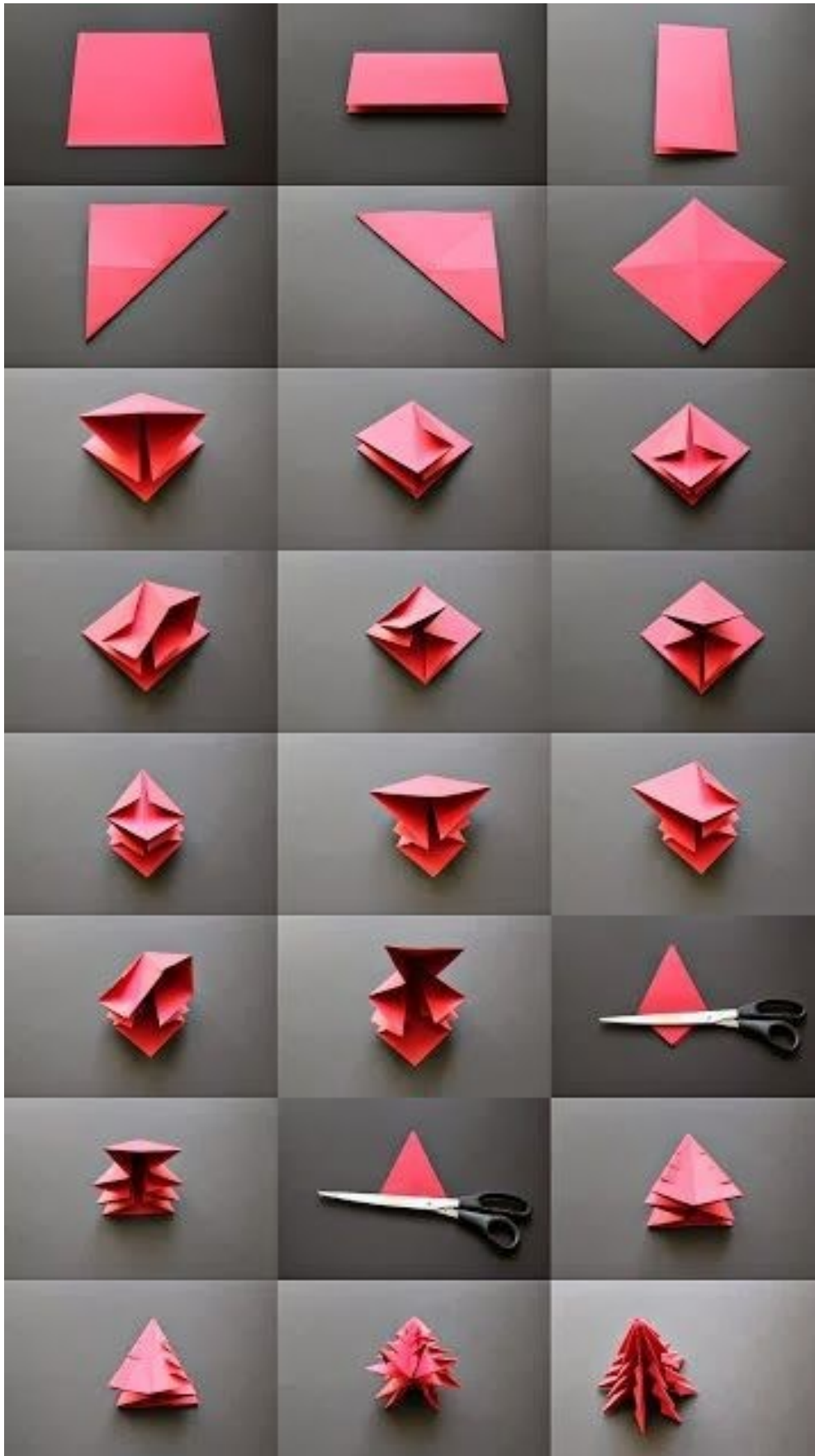

Rose

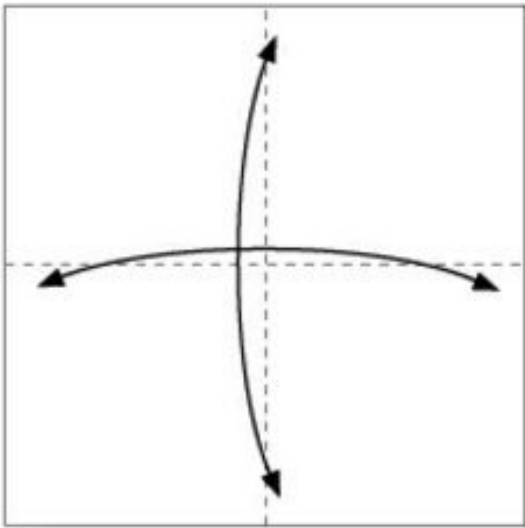

1

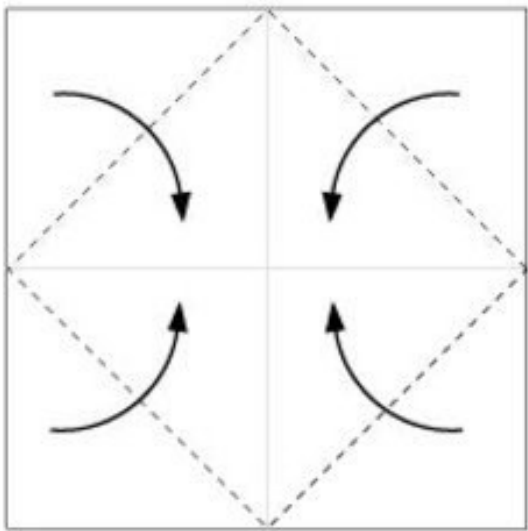

2

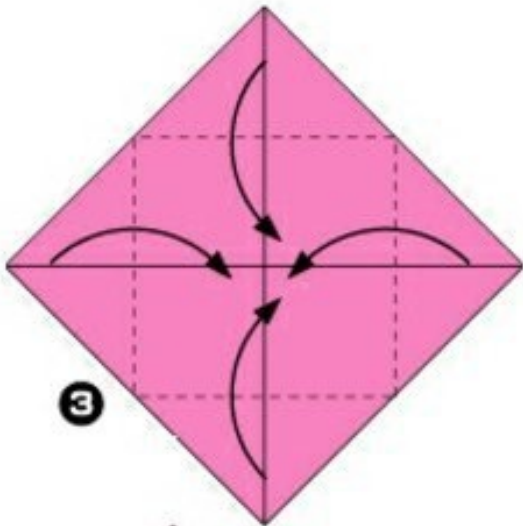

3

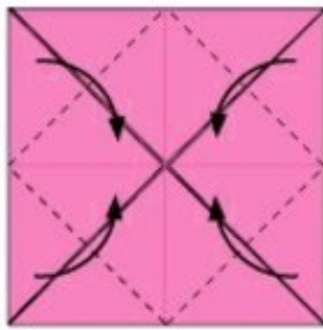

4

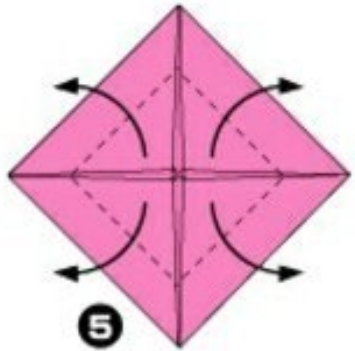

5

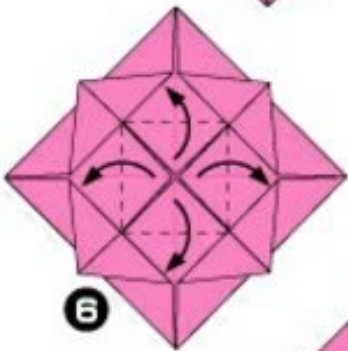

6



7

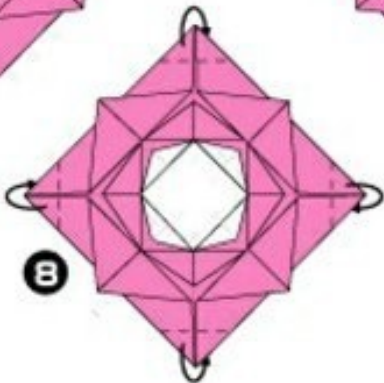

8

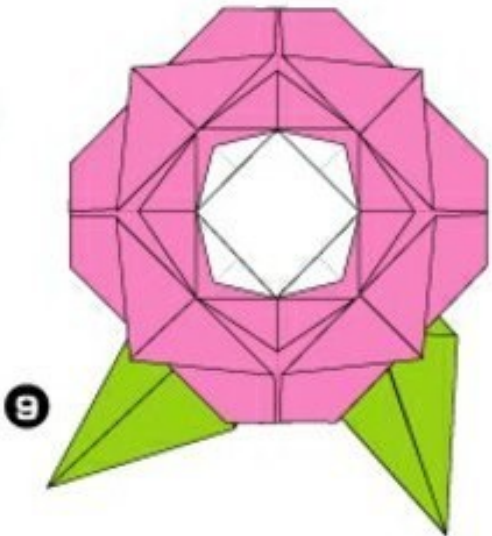

9



Hibou

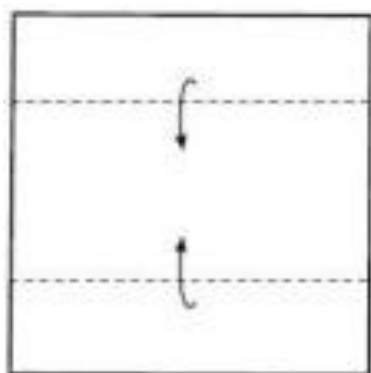

1.

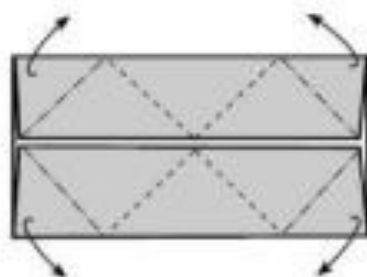

2.



3.

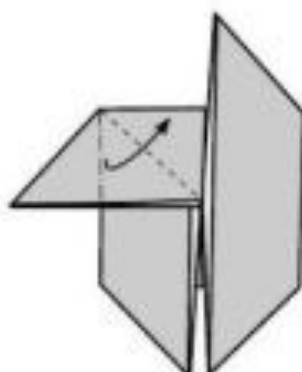

4. Pli aplati.

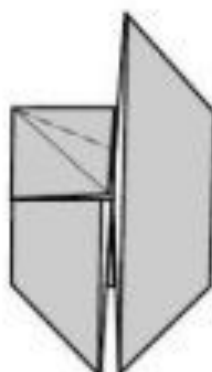

5. Pli montagne.

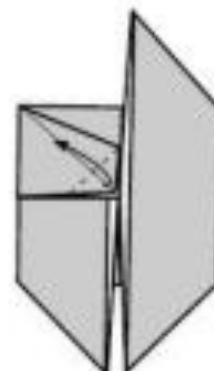

6.

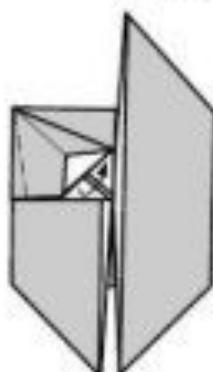

7. Masquer le triangle blanc en faisant glisser le papier.



8.



9.

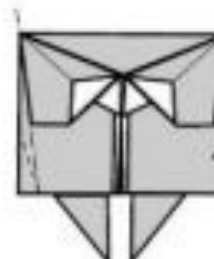

10.



11. Modelage final. Mettre les pattes perpendiculairement au corps.



12.





Souris

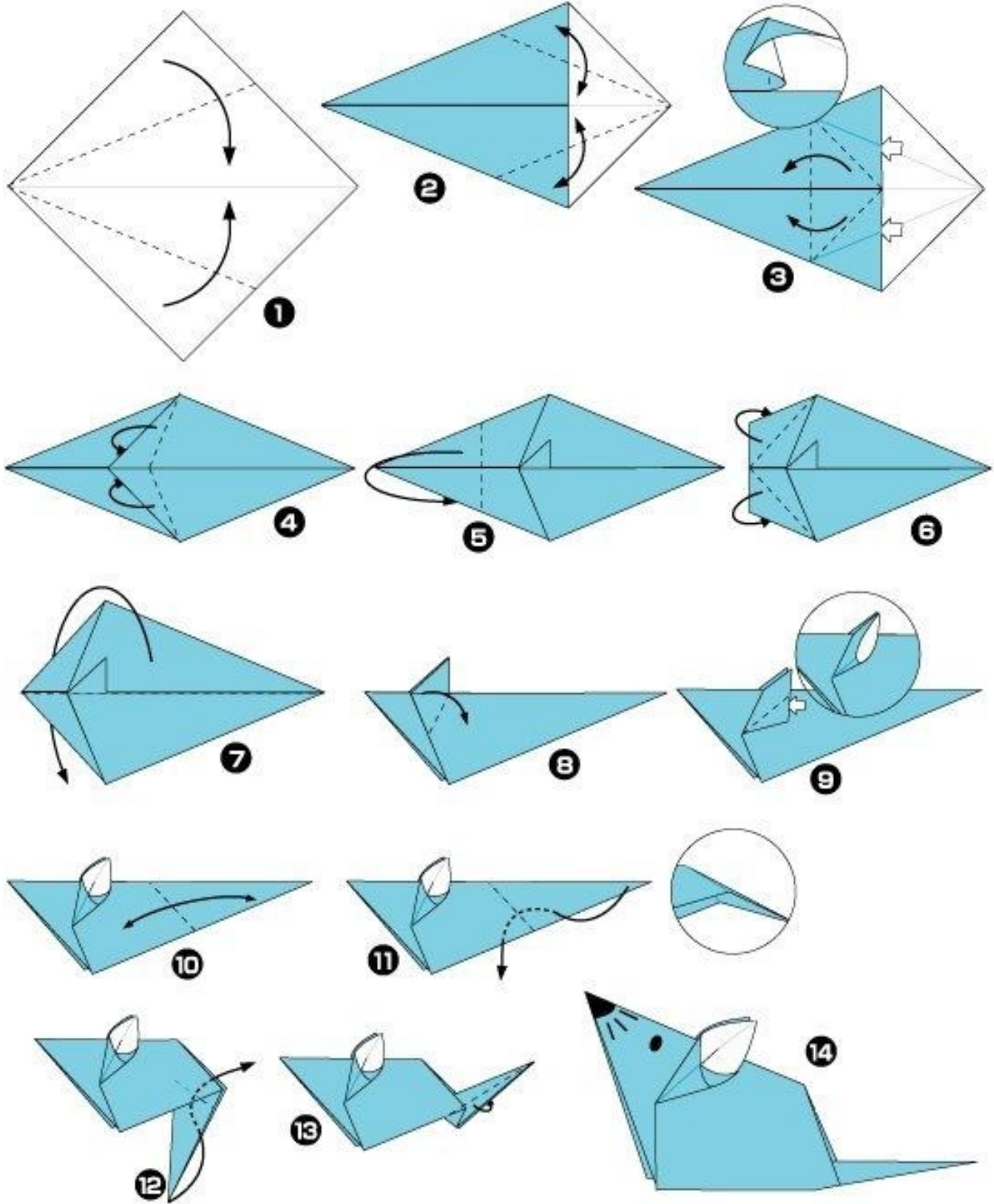



Tulipe

1.



2.

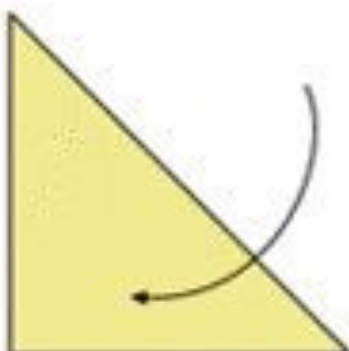

3.

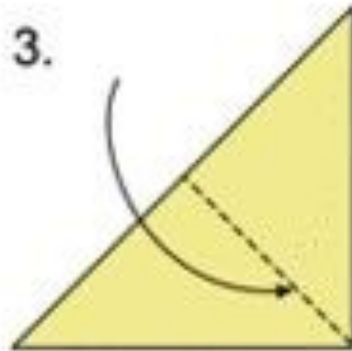

4.

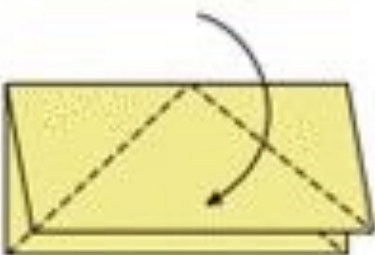

5.



6.

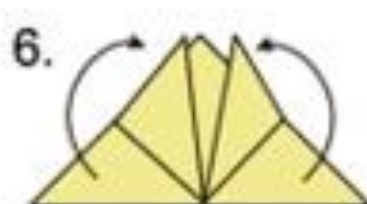

7.

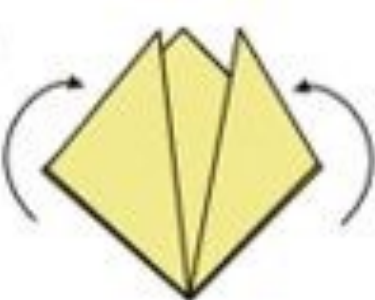

8.



9.

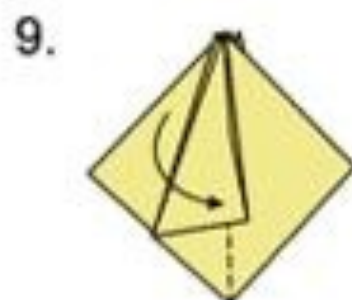

10.

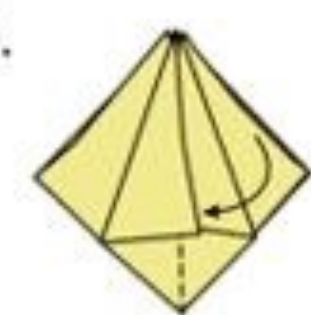

11.

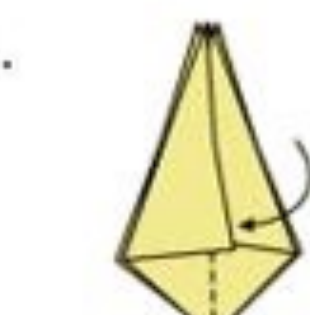

12.



13.



14.





Voilier

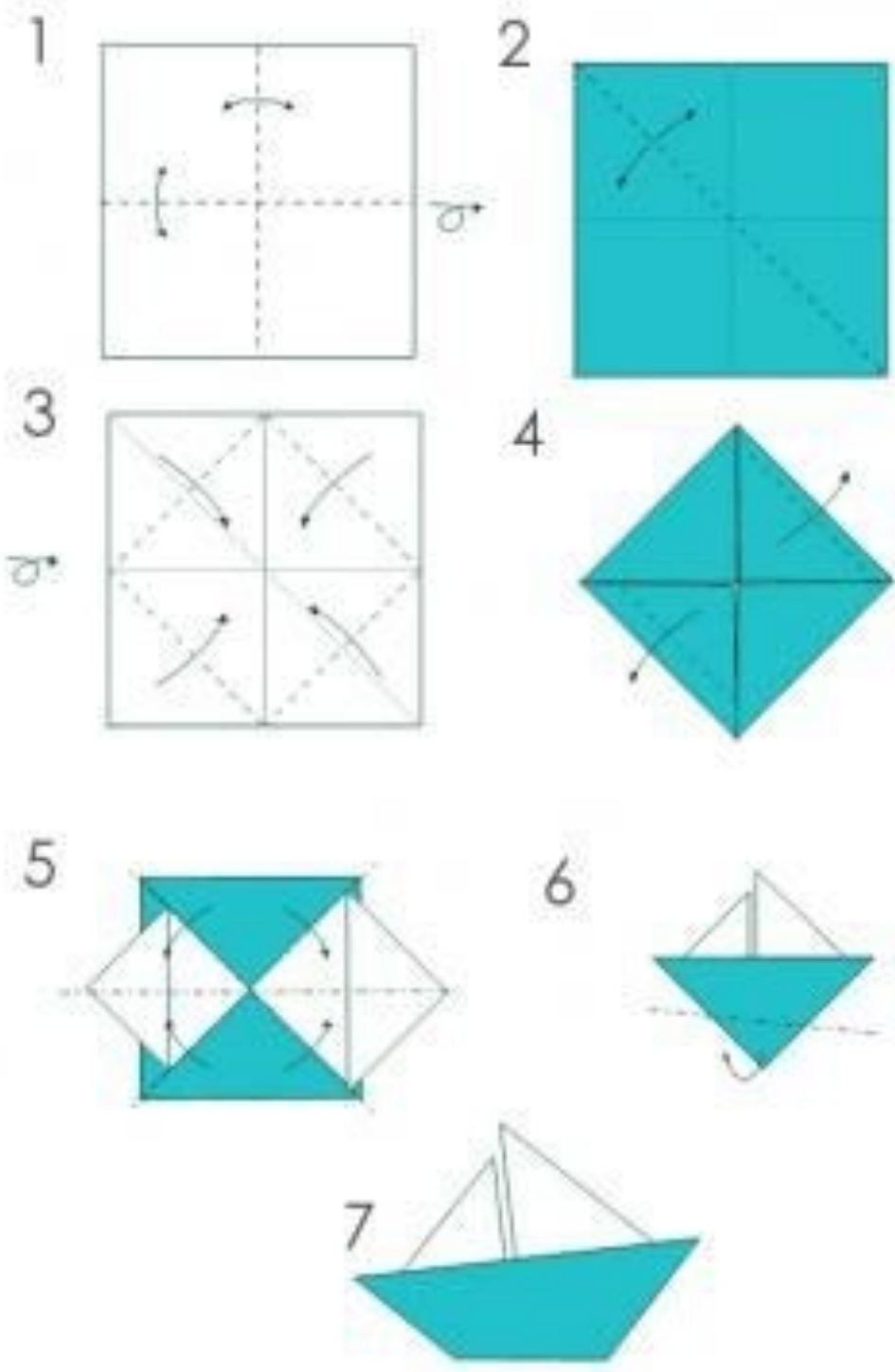



Jet

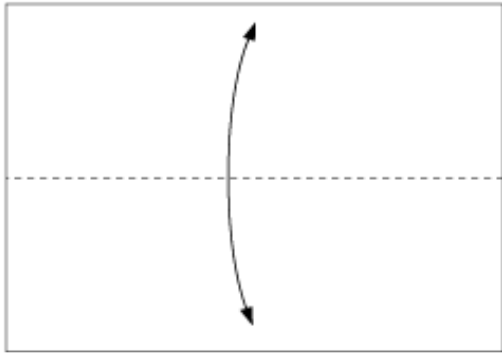

1 Pliez-en deux pour marquer le pli

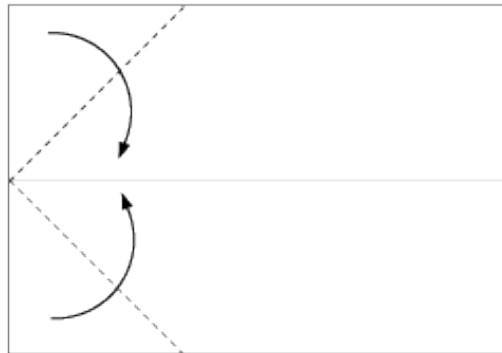

2 Pliez vers le centre de la feuille

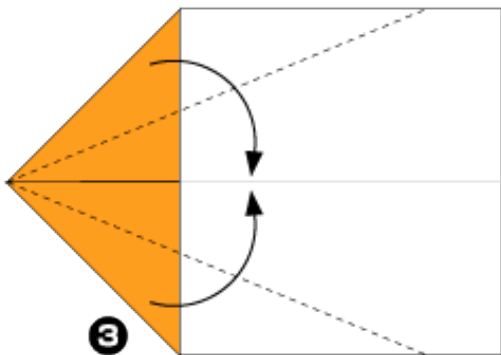

3 Pliez vers le centre de la feuille

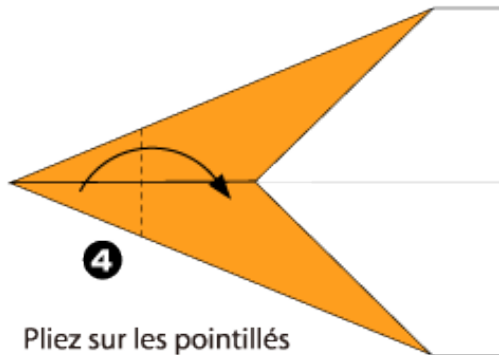

4 Pliez sur les pointillés

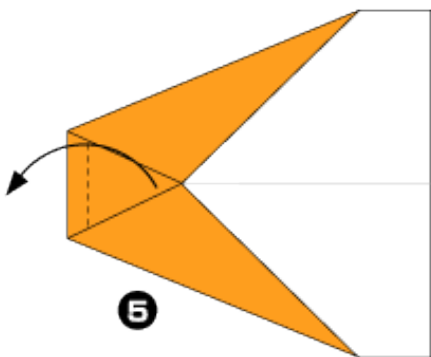

5 Pliez sur les pointillés

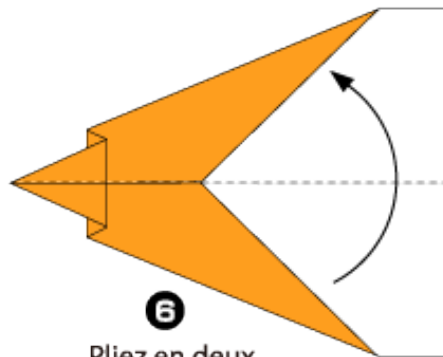

6 Pliez en deux

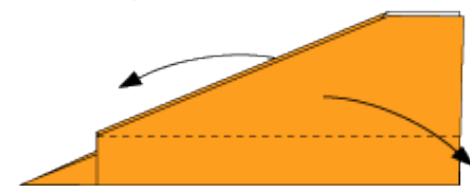

7 Pliez sur les pointillés

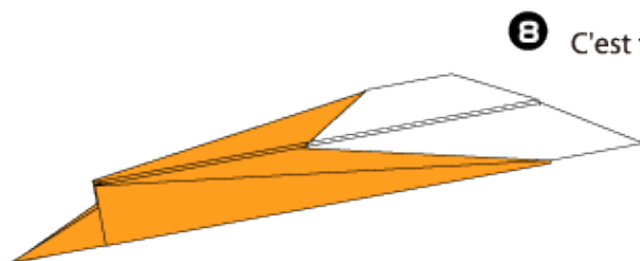

8 C'est fin



Serpent

